

Deutsch

2011-2012

Teo Lehtimäki Oy



Teo Lehtimäki Oy ist der Vertrieb von:
Camoplast Inc.



PPD Group

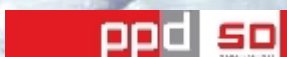

CV Tech-IBC



Wahl Bros
Racing

Updated 04.03.2012

Catalogue 2011-2012

In dem Katalog werden die ursprünglichen Hersteller, seine Produktbilder Codes zitiert, um Sie dabei zu unterstützen, den richtigen Ersatz Produkt zu identifizieren. Unsere gelieferte Ware kann von einem anderen Hersteller produziert werden.

Teo Lehtimäki Oy

Kaarronnevantie 54 61800 Kauhajoki Finland

Vesa Peltonen

mob. +358-40-5769111 Vesa Peltonen

fax +358-6-2311170

info@teolehtimaki.fi

vat. FI08350750

Teo Lehtimäki Oy

Vuopajantie 34 96400 Rovaniemi Finland

Artturi Lehtimäki

mob. +358-400-162110 Artturi Lehtimäki

fax +358-16-366004

E-mail Adressen:

vesa@teolehtimaki.fi

artturi@teolehtimaki.fi

teo@teolehtimaki.fi

Vesa Peltonen

Artturi Lehtimäki

Teo Lehtimäki

Buchhaltung-Finanzien

Vesa Peltonen

vesa@teolehtimaki.fi

www.teolehtimaki.fi

Content

- 3- 4 **Finn hat Raupen**
- 5-13 **Camoplast Raupen**
- 14-16 **Extensions, clips**
- 17-18 **Sprockets**
- 19-19 **Wheels**
- 20-21 **Gleitschienen**
- 22-23 **Federn, pawl kits**
- 24-24 **Shafts, Hood clamps**
- 25-25 **Syncro sprockets**
- 26-26 **Lager, tie rod ends**
- 27-27 **Fuel pump, hooks**
- 28-31 **Ski skins**
- 32-37 **Gleitstäbe**
- 38-44 **Kupplung, driven**
- 45-48 **Kurbelwellenlager**
- 49-49 **Vergaser adapter**
- 50-51 **Engine gaskets**
- 52-58 **Kolben**
- 59-59 **Windschutzscheiben**
- 60-61 **Bremsklötze**
- 62-63 **Chains, sprocket**
- 64-67 **CDI-Zündboxen**
- 68-68 **Starter-Motoren**



**Kupplung, driven
Seite 44, neue Modelle**



2 01-100 Ladegerät 12 V

Note.

Diese und weitere 2000 Seiten:
www.teolehtimaki.fi/Ersatzteilekatalog,
und bitte, überprüfen Sie Ihr Modelltyp

Malli: MXZ 583

Vuosi:

1996

Skidoo

Moottori

Rotax 583 96-

09-772	mäntä, std
09-772-01	mäntä, 0,25 ylikoko
09-772-02	mäntä, 0,50 ylikoko
09-772-03	mäntä, 0,75 ylikoko
09-772-04	mäntä, 1,00 ylikoko
35-505	männäntäpin laakeri
710-214	tiivistesarja, prof
09-167	kampiakselin tiiviste
09-165	kampiakselin tiiviste
09-16002	välitiiviste kampiakseli
35-6206NR	kampiakselin laakeri
35-6207NR	kampiakselin laakeri
35-6305	kampiakselin laakeri
01-158	käynnistimen jousi
01-154	käynn. korjaussarja



Omistaja: **Teo Lehtimäki**, myyty

Kuvassa **Tommi ja Lotta**

Telamatto, leveys cm, pituus cm ,

38 **307 / 22**

04-9793, 04-9009,
04-9830, 04-9753



30-21	L=140 cm musta
30-621	L=140 cm grafiitti
30-210	L=163 cm musta
30-321	L=140 cm keltainen

3700-3800 r/min, kytkentäkierrosluku
7900-8000 r/min, max. kierrosluku

Voimansiirto / Teo Lehtimäki Oy

P50- korvaa alkuperäisen



15-19 (0019)
Kal: 7009
Jousi: 0451-1118
Jousi: 15-54
Shims: 5 + 1

Sähköosat

05-B8 sytytystulppa
01-14342 CDI yksikkö
01-15416 tasasuuntaaja, E-mallit
01-15415 jännitteensäädin
01-14355 puola

**- Diese Seiten
werden fortlau-
fend aktualisiert**

Sukset

Peltisuksi

32-99 **Suksimuovi**
33-20 **CTRL levike 180 mm**
MM142 **Kovametalli**



Breite 38 und 50 cm



04-6000

HSB 54

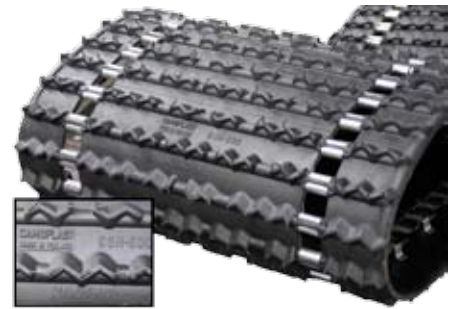

Breite 60 cm

Lynx 20, Lynx 30

04-2450 38 x 245 cm B = 48 st

04-9755 USA 38 x 290 cm B = 58 st

Ockelbo

Lynx 320 und 330 macht

04-3375 38 x 375 cm B = 75 st

04-3377 38 x 385 cm B = 77 st

Lynx 535

Winha

04-5370 50 x 372 cm B = 74 st

Trapper 500

Nordik 500, 540, 500PSS, 550

04-5372 50 x 372 cm B = 74 st

04-5382 50 x 382 cm B = 76 st

Nordik 600 SL / SLE

04-6370 60 x 372 cm B = 74 st

Ockelbo 600 04-6000

Nur die Raupen oben im Inventar, september 2011.

Wir bitten Sie, Ihre Kunden sagen, die Raupen Fertigung in Finnland hat im Sommer 2010 eingestellt. Wir haben nicht diese Raupen länger und wir sind auch nicht erlaubt zu bekommen. Der einzige Weg ist, um den Scneeschlitten zu ändern und legte dort inside-getrieben zu verfolgen. Es ist möglich, erfordert aber besondere Maßnahmen. Auf der nächsten Seite

Die Raupe Produktion bei Camoplast Anlage in Tampere, Finnland ist nicht übertragen und auslaufen. Die Raupe Produktion für die laufende Produktion Motorschlitten wird nach Plattsburgh, NY USA übertragen. Für Motorschlitten Spuren von flach drücken Werkzeuge für Aftermarket-Service produzierten Teile wird die Produktion auslaufen.

Lynx 5900, wie ein neues Modell Raupe ersetzen



schneiden Sie die Rohre

Weld das Stück der Schlauch zwischen die Rohre schneiden Sie. Die Stücke sind geliefert mit die Raupen.

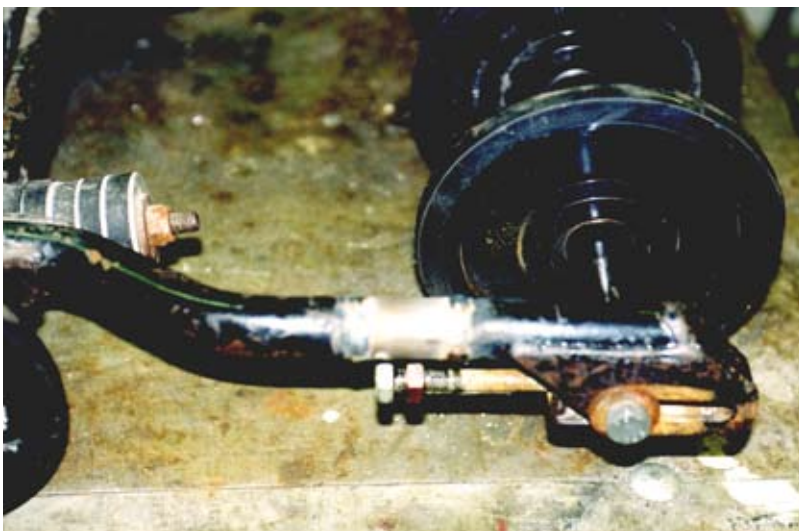

Die Schweißnaht getan worden, Das Schneeschlitten ist, rückseitigen, runden Räder. Sie können ersetzen auch hinten Räder, es sie gibt.

Sie müssen auch ersetzt Antriebskettenrad. Es ist nur möglich, wenn die gibt es eine hexa Antriebswelle.

Wir bevorzugen No-Slip Räder verwenden

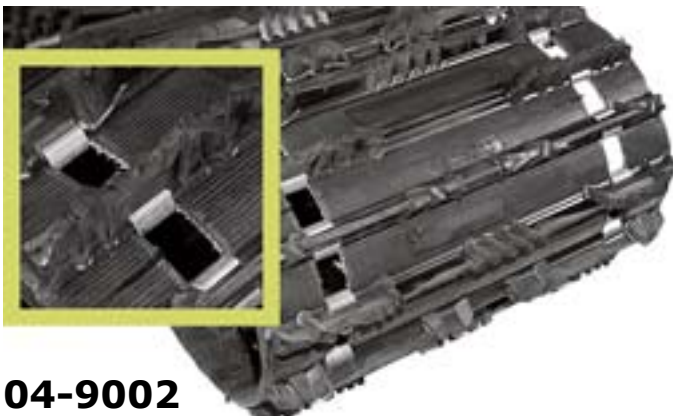

04-9002



Sokosti

04-9005

Utility

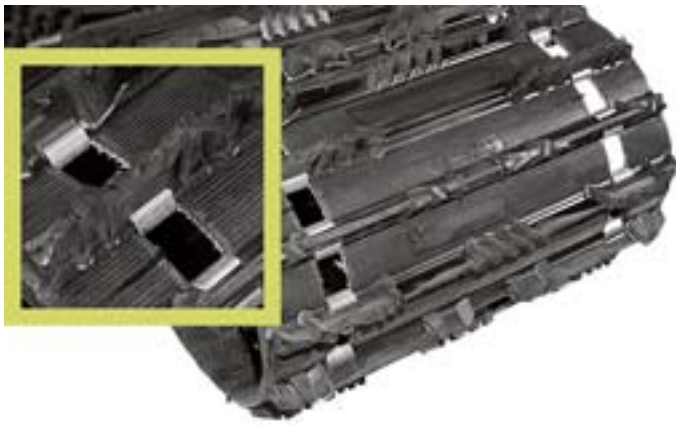

Rip Saw Full clip Pitch 2,52"			
Number	Breite	Länge	cam
	cm	cm	mm
04-9002	50	396	32



Rip Saw Full clip Pitch 2,86"			
Number	Breite	Länge	cam
	cm	cm	mm
04-9089	50	392	38

New



Cobra Full clip Pitch 2,86"			
Number	Breite	Länge	cam
	cm	cm	mm
04-9195	50	392	44
04-9196	50	392	38

Ice Tech			
Number	Breite	Länge	cam
	cm	cm	mm
04-9008	50	396	32

Bearcat, Scandik WT. Lynx, Polaris, Yamaha Viking



Explorer 25 mm Full clip			
Number	Breite	Länge	cam
	cm	cm	mm
04-9806	38	396	25

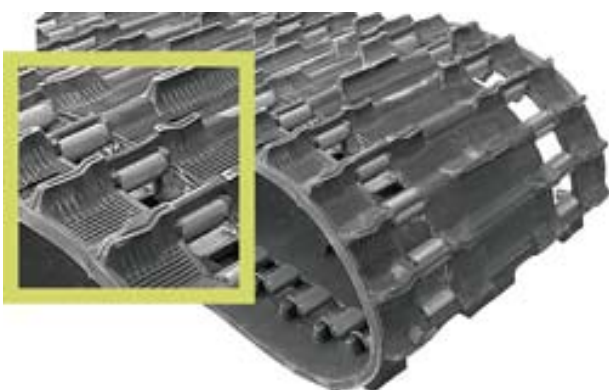

Explorer 19 mm full clip			
Number	Breite	Länge	cam
	cm	cm	mm
04-9011	38	353	19

Cam 19 mm, Elan, Safari, Lynx, Old models



Durasport 15 mm full clip			
Number	Breite	Länge	cam
	cm	cm	mm
04-9755	38	290	15
wheel boggie			
04-9756	38	290	15
slide suspension			

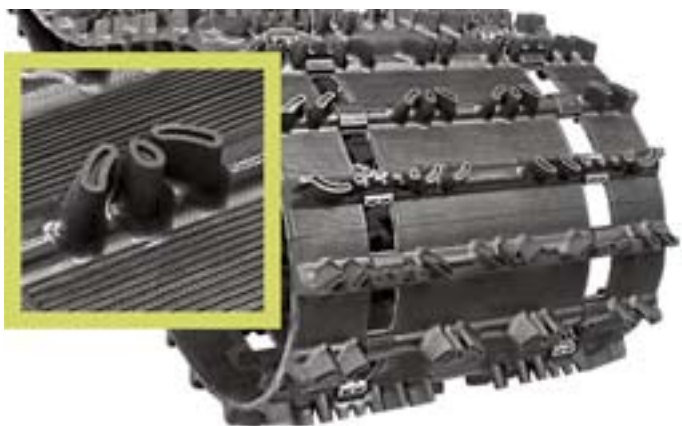

Hack Saw 25 mm full clip			
Number	Breite	Länge	cam
	cm	cm	mm
04-9009	38	307	25
04-9010	38	345	25

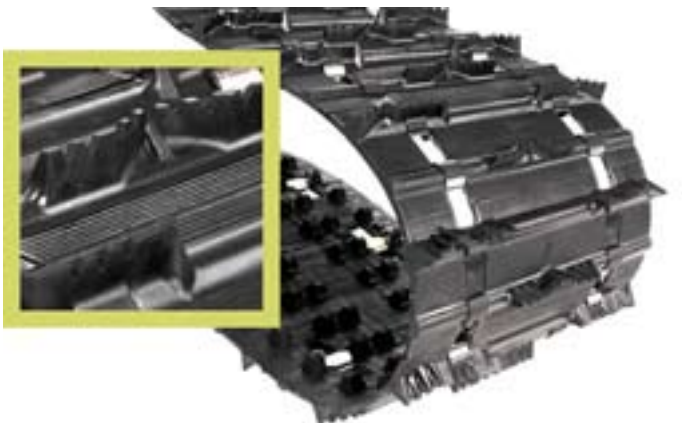

Challenger 25 mm 2/1 cleat			
Number	Breite	Länge	cam
	cm	cm	mm
04-9793	38	307	25
04-9794	38	345	25



Durasport 25 mm full clip			
Number	Breite	Länge	cam
	cm	cm	mm
04-9753	38	307	25
04-9863	38	345	25

Special tracks



Yamaha, Polaris

Free ride 38 mm full clip			
Number	Breite	Länge	cam
	cm	cm	mm
04-9033	36	307	38
04-9034	36	345	38
04-9044	36	365	38



Arctic Cat

Hack Saw 25 mm full clip			
Number	Breite	Länge	cam
	cm	cm	mm
04-9960	34,3	325	25

**New
XC Pro**

Pitch 2,86"



XC Pro 44 mm full clip			
Number	Breite	Länge	cam
	cm	cm	mm
04-9169	38	305	44
04-9189	38	348	44



Rip Saw profiles



Pitch 2,52"

Rip Saw 32 mm

Rip Saw 32 mm			
Number	Breite	Länge	cam
	cm	cm	mm
04-9146	38	307	32
04-9040	38	325	32
04-9922	38	345	32
04-9006	38	365	32
04-9007	38	385	32
04-9925	38	403	32
Special width			
04-9021	40,5	345	32
Pitch 2,86"			
04-9049	38	305	32
04-9080	38	348	32
cleat	full clip		
cleat	every 3 rd, open		
cleat	every 3 rd, closed		

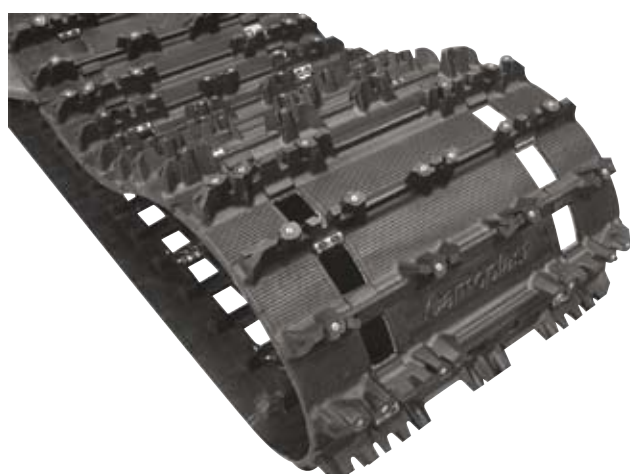

Ice Ripper, jako 2,52"

Ice Ripper 32 mm cleat 2/1			
Number	Breite	Länge	cam
	cm	cm	mm
04-9077	38	307	32
04-9079	38	345	32

Ice Ripper , pitch 2,86"

Ice Ripper 32 mm full clip			
Number	Breite	Länge	cam
	cm	cm	mm
04-9190	38	305	32
04-9191	38	348	32

Rip Saw 38 mm



Rip Saw 38 mm full clip			
Number	Breite	Länge	cam
	cm	cm	mm
04-9112	38	307	38
04-9045	38	325	38
04-9113	38	345	38
cleat	every 3 rd, open		



Cobra 34 mm fullclip pitch 2,52			
Number	Breite	Länge	cam
	cm	cm	mm
04-9052	38	307	34
04-9081	38	325	34
04-9061	38	345	34

Cobra 34 mm fullclip pitch 2,86			
Number	Breite	Länge	cam
	cm	cm	mm
04-9092	38	305	34
04-9093	38	348	34
04-9094	38	370	34



Sokosti 38 mm full clip			
Number	Breite	Länge	cam
	cm	cm	mm
04-9003	38	365	38
04-9004	38	384	38
04-9005	38	403	38
cleat	every 3 rd, open		

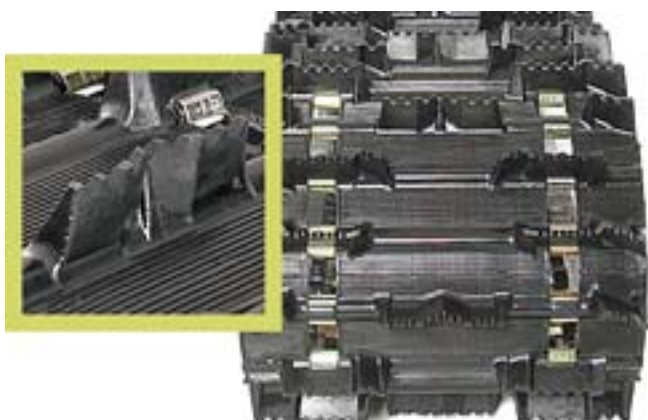

Intense 38 mm full clip			
Number	Breite	Länge	cam
	cm	cm	mm
04-9930	38	307	38
Note: not soft compound			
04-9108	38	345	38

pitch 2,86"



Rip Saw 44 mm full clip			
Number	Breite	Länge	cam
	cm	cm	mm
04-9159	38	305	38
04-9076	38	348	38
04-9139	38	305	44
04-9096	38	348	44
04-9121	38	370	44

Back Country pitch 2,52" New design and new rubber compound



Back Country 44 mm full clip			
Number	Breite	Länge	cam
	cm	cm	mm
04-9140	38	307	44
04-9141	38	325	44
04-9142	38	345	44
04-9143	38	365	44



Pitch 2,86"

Challenger 44 mm full clip			
Number	Breite	Länge	cam
	cm	cm	mm
04-9069	40,5	305	44
04-9070	40,5	348	44
04-9167	40,5	370	44
04-9186	40,5	348	44
04-9187	40,5	370	44
04-9187	40,5	392	44

Pitch 2,86"



Back Country X 44 mm full clip			
Number	Breite	Länge	cam
	cm	cm	mm
04-9128	38	305	44

Pitch 2,86"

New



Rip Saw II 38 mm full clip			
Number	Breite	Länge	cam
	cm	cm	mm
04-9156	38	305	38



Pitch 2,86"

Challenger 51 mm full clip			
Number	Breite	Länge	cam
	cm	cm	mm
04-9086	38	348	51
04-9087	38	370	51
04-9088	38	391	51

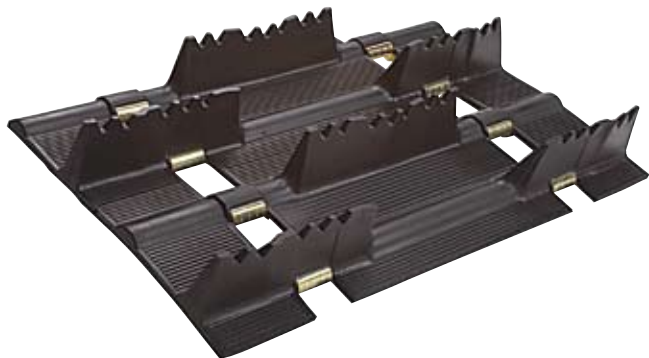

Pitch 2,86"

Challenger 63 mm full clip			
Number	Breite	Länge	cam
	cm	cm	mm
04-9102	40,5	394	63
04-9103	40,5	414	63
04-9103	38	394	63

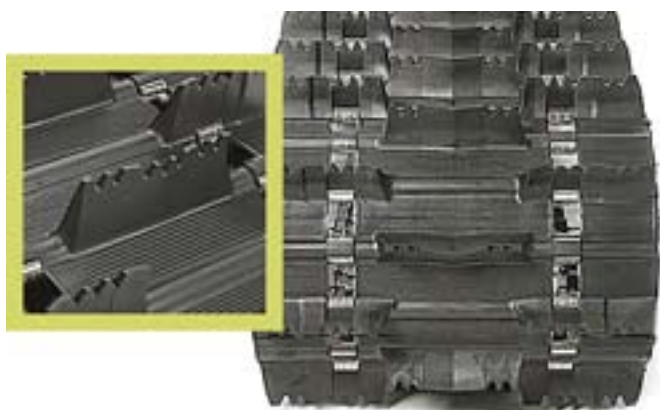

Challenger 51 mm full clip			
Number	Breite	Länge	cam
	cm	cm	mm
04-9798	38	307	51
04-9797	38	345	51
04-9875	38	365	51
04-9876	38	384	51
04-9884	38	403	51
04-9899	40,5	365	51
04-9919	40,5	384	51
04-9941	40,5	403	57

Pitch 2,52"



Challenger 44 mm full clip			
Number	Breite	Länge	cam
	cm	cm	mm
04-9933	40,5	345	44

Pitch 3,00"



Challenger 57 mm full clip			
Number	Breite	Länge	cam
	cm	cm	mm
04-9984	38	358	57

Challenger 63 mm full clip			
Number	Breite	Länge	cam
	cm	cm	mm
04-9942	38	365	63
04-9943	38	411	63
04-9174	38	388	63
04-9974	38	396	63

Pitch 2,86"



Challenger Ext 63 mm full clip			
Number	Breite	Länge	cam
	cm	cm	mm
04-9144	40,5	371	63
04-9145	38	371	63

Challenger Ext 57 mm full clip			
Number	Breite	Länge	cam
	cm	cm	mm
04-9064	40,5	371	57
04-9065	40,5	391	57
04-9066	40,5	414	57

Peak 2,5

New

Pitch 2,86"



Peak 2,5 63 mm full clip			
Number	Breite	Länge	cam
	cm	cm	mm
04-9182	38	370	63
04-9181	38	391	63
04-9180	38	414	63
04-9179	40	370	63
04-9178	40	391	63
04-9177	40	414	63

Extendings

04-3050
universal 12 cm



04-3080
Yamaha 20 cm



04-3040
universal 25 mm shaft
20 cm



04-3060
Yamaha 12 cm



04-3300
Lynx 20 cm

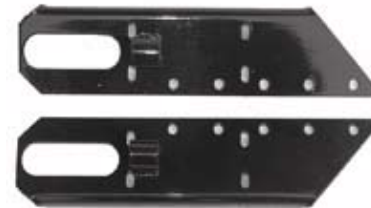

04-3070
Zur Verkürzung
Lynx G-Typ.
320 cm lang boggie
gemacht Verwendung
Raupe 307 cm lang

04-3000



Aluminium-Profilen



04-3001

chassie 400-420 mm
Länge 600 mm

04-3003

chassie 415-430 mm
Länge 600 mm

Durch den Einsatz dieses Profil, kann der chassie werden erweitert um max. 400 mm. Beachten Sie, dass Sie können nicht an eine Anhängerkupplung Haken an diesem Profil ohne entsprechende Halterungen.



04-3002

chassie 400-410 mm
Länge 200 mm

Durch den Einsatz dieses Profil, das chassie erweitert werden kann von max. 150 mm.

Clip

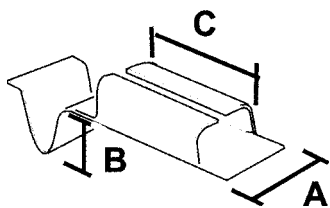

p/n	A	B	C
38-01	18	-	30
38-02	21	-	30
38-03	20	16	30
38-04	23	18	21
38-05	21	-	38
38-07	21	-	19
38-08	22	-	20
38-09	19	14	25
38-10	19	-	25
38-11	19	16	37

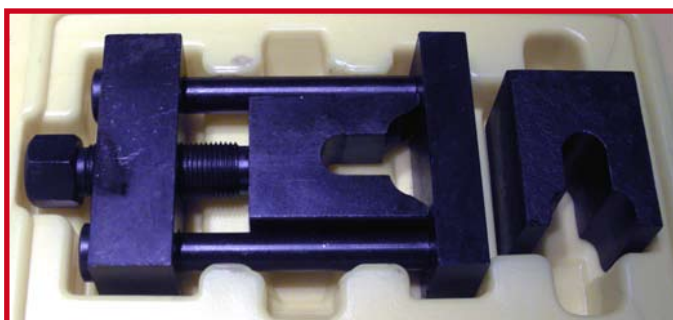
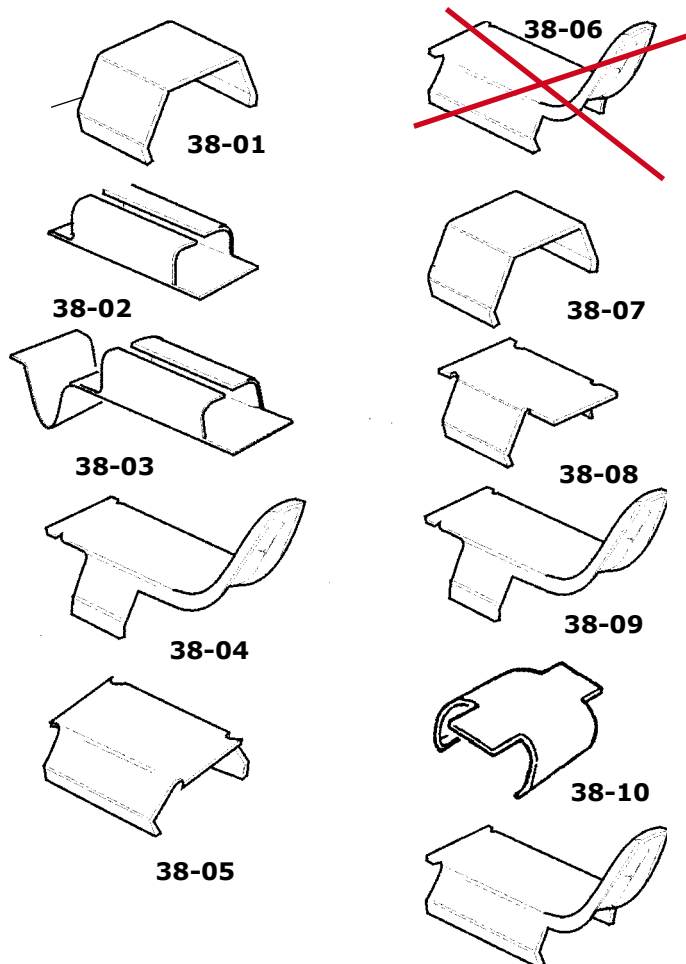

Raupe-Clip-Werkzeug, Schrauben Typ

Es passt die 1 1 / 2 "-Clips
und auch die 1 "-Clips mit
schmalen einfügen

Part number: 38-100

04-9925 + 04-3000 = 403 cm

Diese alte 345 cm Raupe kann mit 403 cm Predator ersetzt werden wie auf dem Bild unten gezeigt. Boggie wurde erweitert, 180 mm Umlenkrollen an der Hinterachse. 04-3000 Erweiterung Kit wird mit allen benötigten Teile, außer Schrauben und Nieten geliefert werden



365 cm



384 cm



Lynx

04-9040 38 x 325 cm



Orig. Raupe 320 cm
oder 330 cm lang

Anpassung ist lang
genug



No Slip sprockets,

patent by Wahl Bros.



21-08PO

Number	Tooth	Pitch	Outer dia	Shaft / mm	Bore
39-00	7	2,52"	136 mm	25,0-27,0	24,0 mm
39-01	7	2,52"	136 mm	27,0-29,0	26,0 mm
39-02	7	2,52"	136 mm	32,0-34,0	31,0 mm
39-05	8	2,52"	158 mm	25,0-27,0	24,0 mm
39-06	8	2,52"	158 mm	32,0-34,0	31,0 mm
39-08	8	2,52"	158 mm	27,0-29,0	26,0 mm
39-09	9	2,52"	177 mm	27,0-29,0	26,0 mm
39-10	10	2,52"	197 mm	27,0-29,0	26,0 mm
39-15	7	2,86"	155 mm	25,0-27,0	24,0 mm
39-16	7	2,86"	155 mm	32,0-34,0	31,0 mm
39-17	7	2,86"	155 mm	27,0-29,0	26,0 mm
39-18	8	2,86"	181 mm	27,0-29,0	26,0 mm
39-26	7	3,00"	163 mm	32,0-34,0	31,0 mm
39-27	7	3,00"	163 mm	27,0-29,0	26,0 mm
39-28	8	3,00"	190 mm	27,0-29,0	26,0 mm
39-42	7	2,86"	155 mm	Tube shaft	Skidoo, Lynx
39-43	8	3,00"	190 mm	Tube shaft	Skidoo, Lynx
21-08PO	8	3,00"	190 mm	Tube shaft	Polaris

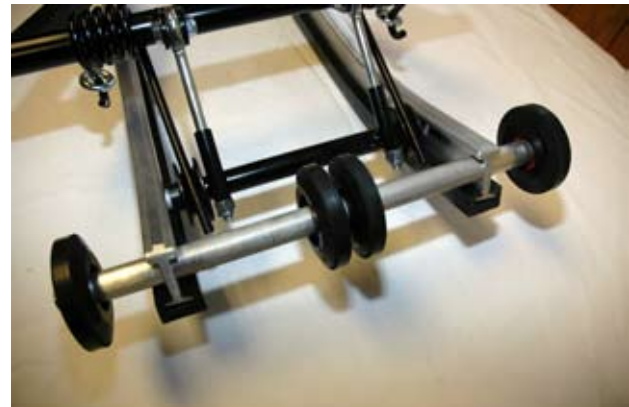

Anti-Stab wheel kit

Stab Radsatz helfen zu verhindern, Raupe spearing durch die Verhinderung der Strecke kommen in contact mit den Spitzen der Hängeleisten.

- 39-791 Center, 223 mm shaft
Arctic Cat, Yamaha
- 39-793 Center, 220 mm shaft
Skidoo, Polaris, Lynx

Sprockets

Number	Tooth	Pitch	Bearing	Note
20-5285	9	50 mm	35-6205	Ockelbo, width 25 mm
20-5286	9	50 mm	35-6205	Ockelbo, Trapper, width 30
20-5287	11	50 mm	35-6205	Lynx, Nordik 300
20-5288	10	50 mm	35-6205	Nordik PSS, 540, 550
20-5289	9	2,52"	35-6205	track 9806, 9925, 9005
37-00	9	50 mm	-	Sprocket, width 22 mm
37-01	9	50 mm	-	Sprocket, width 30 mm
37-03	11	50 mm	-	Sprocket, width 30 mm
37-04	11	50 mm	hexa 27mm	Sprocket, width 30 mm
37-06	-	-	-	For wheel suspens 127 mm



37-03



37-04



20-5285, 20-5286



20-5287



20-5288



20-5289

Sprockets



Number	Tooth	Pitch	External	Shaft / mm	Hexa
21-07N	7	2,52"	136 mm	Square	Square 21,0
21-07K	7	2,52"	136 mm	25,0-27,0	24,0 mm
21-07G	7	2,52"	136 mm	27,0-30,0	26,0 mm
21-08AC	8	2,52"	158 mm	25,0-28,0	24,0 mm
21-08LY	8	2,52"	158 mm	32,0-34,0	31,0 mm
21-09PO	9	2,52"	177 mm	25,0-28,0	24,0 mm
21-09LY	9	2,52"	177 mm	32,0-34,0	31,0 mm

Idler wheels

Number	Diameter	Lager	Farbe	Fit
20-82	082	35-620258	schwarz	
20-108	108	35-620258	schwarz	Skidoo, Lynx, Polaris
20-117	117	35-6205	schwarz	Polaris
20-127	127	35-620258	schwarz	Lynx
20-130	130	35-6004	schwarz	Yamaha
20-133	133	35-6004	schwarz	Lynx, Ockelbo
20-135	135	35-6205	silber	Skidoo, Trapper, Nordik
20-135F	135	35-6205	silber	Full moon, Skidoo
20-5350	135	35-6205	silber	Polaris, inserts..
20-5630	143	35-6205	schwarz	Arctic Cat
20-5630H	143	35-6205	silber	Arctic Cat
20-5630G	143	35-6205	grün	Arctic Cat
20-155	155	35-6205	schwarz	Skidoo, Trapper, Nordik
20-6380H	160	35-6205	silber	Polaris, Arctic Cat
20-6375S	160	35-6205	blau	Polaris, Arctic Cat
20-6375P	160	35-6205	rot	Polaris, Arctic Cat
20-165K	165	35-6205	gelb	Lynx
20-165P	165	35-6205	red	Lynx
20-165H	165	35-6205	silber	Lynx
20-180	180	35-6205	silber	Lynx, 04-3000 flip
20-131	180	35-6204	schwarz	Yamaha
20-200	200	35-6205	schwarz	alle



Inserts

20-34 insert 3/4 " pair

20-58 insert 5/8 " pair



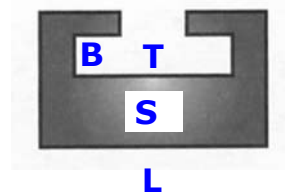
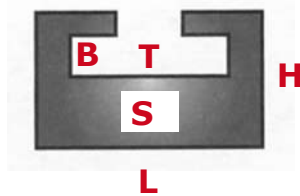

Gleitschienen

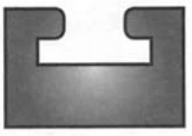

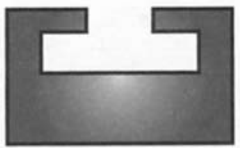
Arctic Cat	Breite L mm		Höhe H		Dicke S	B ,mm	T ,mm
	30		20		9,5	5	19
	Number	Länge cm	Farbe	Arctic Cat, alle Modelle nach -78			
	30-10	140	schwarz				
	30-610	140	graphit				
	30-410	163	orange				
30-167	167	schwarz	Arctic Cat, Super Jag, Karibo				

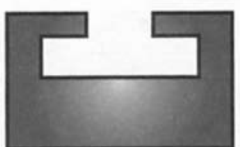
Skidoo, Lynx	Breite L mm		Höhe H		Dicke S	B ,mm	T ,mm
	37,5		19		10	5	26
	Number	Länge cm	Farbe				
	30-01	140	schwarz	Lynx, up tp G-type, und alle utility models			
	30-601	140	graphit				
30-010	163	schwarz	Skidoo alte Modelle bis -96				
Trapper, Nordik	Trapper, Nordik-300,500,600						

Skidoo Nordik	Breite L mm		Höhe H		Dicke S	B ,mm	T ,mm
	37		20		10	7	24,5
	Number	Länge cm	Farbe	Nordik 377 R, 540, 550			
	30-00	155	weiß.				

Skidoo, Lynx	Breite L mm		Höhe H		Dicke S	B ,mm	T ,mm
	38		17		9,5	4,5	22
	Number	Länge cm	Farbe				
	30-21	140	schwarz	Lynx G-type-,			
	30-621	140	graphit	Skidoo REV, RT & RF, SC4 suspens.			
	30-210	163	schwarz				
30-321	140	gelb					

Skidoo, Lynx	Breite L mm		Höhe H		Dicke S	B ,mm	T ,mm
	38		15		7	5	27
	Number	Länge cm	Farbe	Formulat, GT mod., Mach1, Z, MXZ,			
	30-260	140	schwarz	Legend, MX Rev, Summit, Renegade			
	30-270	151	graphit				
	30-280	163	schwarz				
	30-360	140	gelb				
	Lynx 2009- RS 600, SC 4 suspension,						

Gleitschienen

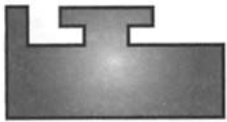
Polaris	Breite L / L mm		Höhe H	Dicke S	B ,mm	T ,mm
	31	37		11		
	Number	Länge cm	Farbe			
	30-15	140	schwarz	Up to 2000 all		
	30-615	140	graphit	XTRA 10, XTRA 12 narrow profile		
	30-150	145	schwarz			
note: dimensions	30-618	140	graphit	Polaris- Storm, XCR, breite Profil		

Polaris	Breite L mm		Höhe H / H	Dicke S / S	B / B	T / T
	32		19,5 22,0	9/ 11	5 / 6	22/23
	Number	Länge cm	Farbe	Edgr RMK 03-05, Edge 2000-05,		
	30-23	140	schwarz	340 mallit -99-05, Lite 97-98		
	30-623	140	graphit	Indy Sport -97-99,		
	30-230	167	schwarz	2000-		
note: dimensions	30-240	163	schwarz	gen II RMK, XC, M-10 , Indy Edge		

Yamaha	Breite L mm		Höhe H	Dicke S	B ,mm	T ,mm
	30			7		
	Number	Länge cm	Farbe	Phaser, Ovation, SRV, SS		
	30-12	140	schwarz			
	30-612	140	graphit			

Yamaha	Breite L mm		Höhe H	Dicke S	B ,mm	T ,mm
	30		15	7	5	24
	Number	Länge cm	Farbe			
	30-16	140	schwarz	Viking, Exciter 87-90, Phaser 90-99		
	30-616	140	yellow	V-max 92-97,		
				V-max 500-600 94-96		

Yamaha	Breite L mm		Höhe H	Dicke S	B ,mm	T ,mm
	30		18	10	5	24
	Number	Länge cm	Farbe			
	30-20	140	schwarz	V-max 97-03,		
	30-200	145	schwarz	Mountain max 97-02		
	30-620	140	graphit	SX, SRX, SXR, 98-04		

Yamaha	Breite L mm		Höhe H	Dicke S	B ,mm	T ,mm
	34		18	10	5	25
	Number	Länge cm	Farbe			
	30-625	145	graphit	RX1 models 2005- RS models 2005-		
	30-635	157	graphit	Apex, Attack 2006-		
				Nytro 2006-		

Start Ferdern

01-1560	Rotax	414 783 400
01-158	Rotax	420 939 115
01-2080	Arctic Cat Polaris Yamaha	3001-077 308-3185 8YO-15713-00-00
01-2083	Arctic Cat Polaris	3002-921 308-3495
01-206	Sachs	
01-207	Kohler	

Pawl kit Rotax

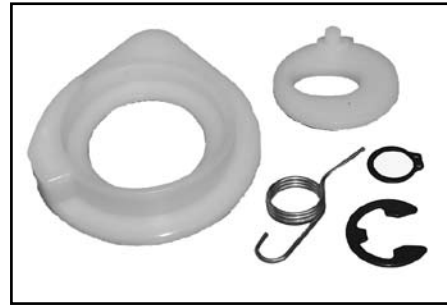

01-154



01-153

Federn vorne / paar

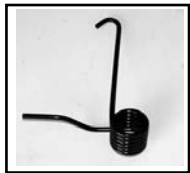

41-3281

8,0mm

mm. Lynx 250,3900

41-3000

9,0mm

mm. Lynx 5900



41-8797

10mm

mm. Ranger King
538797, 538798

41-8796

9,0mm

538796, 538795



41-1530

9,0mm

mm Lynx 5900,
ring and hook

40-4715

8,5mm

Nordik 500, 540, 550, 600



40-CA

8,0mm

mm. Karibo, Arctic Cat

Federn hinten / Superstark / Paar



40-PZ

Yamaha Phazer 07-



40-LT

Yamaha Mt. Lite

Federn hinten / Superstark / Paar



40-AC 11,5 MM
Arctic Cat the last models



40-POLA 11,5 MM
8 turns
Polaris, Skidoo, Lynx



40-VI 12,0 MM
Yamaha Viking



40-PO 11,5 MM
9 turns
Polaris onward 1990



40-EDGE 11,0 MM
Polaris EDGE



40-POL 11,5 MM
Polaris up to 1989, with hook

Federn hinten / normal / pair



41-8805 Lynx Ranger



41-4175 Lynx 3900 S



40-4721 Nordik 500-600



41-1531 Lynx



41-4277 Lynx 10,0 MM
Rechte Hand Federn in den Bildern gezeigt.



41-4500 Lynx 9,0 MM

40-4716

Antriebswelle 5900

11-59 Antriebswelle 5900

For 1989-1995 makes



Rear Welle



11-02	3450701	Lynx 250, 360
11-03	3501775	Lynx GLX, 5900, 650
11-04	3501911	Lynx GLX, 5900, 650
11-08	5492814	rear shaft Lynx 250
11-09	5493615	rear shaft Lynx 5900
11-10	5496216	rear shaft Lynx 360, 3900
11-11	05032390	rear shaft Nordik 500, 540
11-12	05032389	rear shaft Nordik 300, 377R

Counter shaft



11-20	5394111	Lynx 250S, 3900S
11-21	5398073	Lynx 360S, Ranger
11-22	539990	Fox -99
11-23	5146138	Fox 00-
11-25	875138073	Synco

Hood Latch



12-13402



12-135

12-13402
Lynx, Yamaha



12-131

12-135
Polaris 75-83



12-13501

12-131

12-13501
Polaris 84-05



Neu, neu

43-27

Sprocket **8751-46293**
 27 teeth v. 1989-1997
 Lynx 5900, 3900, 6900



43-68 600cc liquid cooled years.2002-05

Sprocket **Z=53 8751-56114**
 Sprocket **Z=31 8751-56156**
 Sprocket **Z=28 8751-56206**



43-32

Sprocket **8751-46042**
 32 teeth
 v. 1989-1996
 Lynx 5900, 3900, 6900



Syncro gears

43-65 from 1992

sprocket, wide z=64 8751-55048
 sprocket, left z=33 8751-47643
 sprocket, right z=33 8751-47644

43-64 up to 1992

sprocket, wide z=64 8751-55048
 sprocket, left z=31 8751-47202
 sprocket, right z=31 8751-47203



Sisu gear box

43-66 1996-2003

sprocket Z=55 8751-56048
 sprocket Z=31 8751-56049
 sprocket Z=28 8751-56050

Gaskets



08-101

Rotax 377-447-503
manifold

08-100

Rotax 377-447-503
carburetor

08-102

Polaris
manifold

Repair kits (MIKUNI)



08-103

Mikuni (07-187-05)

08-104

Mikuni (07-187-11)



03-7000

Primer pump

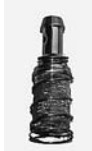

03-7311

In tank filter



Throttle extension kit

03-5000 Throttle extension kit

20 cm



Fuel pumps



31 l.

08-188



70 l.

08-200



08-187

Haken



12-01



12-02 Skidoo



12-03 Polaris



12-04
12-04XP

Skidoo
Skidoo -09-
Lynx 09-

Extra wide skis

31-01	Width	250 mm	8 mm
31-02	Width	200 mm	8 mm
31-03	Width	230 mm	8 mm
31-09	Width	230 mm	8 mm
31-00	Alpine II		8 mm
31-04	Width	195 mm	8 mm

design model

Polaris 08-



**Only 70 cm soft snow.
If the belly pan is not sliding
on the snow, you will get sweaty.**



31-09 Polaris 08- deep in the middle



31-01

Vuotsolainen

31-02

Vuotsolainen



31-03

Vuotsolainen

ADJ ski

**31-04 Vuotsolainen for Pilot / RMK ski, design model
width 195 mm, 8 mm**



You can use 1, 2, or 3 carbide runners



31-04

31-04 Vuotsolainen for Pilot ski

31-03 L / left

230 mm

Vuotsolainen for Pilot ski

31-03 R / right

230 mm

Vuotsolainen for Pilot ski



31-05 Yamaha Viking, with pre-holes



33-50

33-50 Narrow Pilotti ski



Plastics for plastic skis



33-10 Arctic Cat



33-30 Katamaran ski



33-40 Polaris



33-60- Skidoo / Lynx flex



**33-20 Lynx CTRL
not pre-drilled, multipurpose**



33-50 Pilot, narrow model



33-70 Skidoo1996-



33-80 Yamaha SRX 1998-



33-90 Yamaha 2000 / Skidoo / Lynx



33-99 Yamaha RX-1

**31-06 Bottom pan
6 x 800 x 1000 mm**

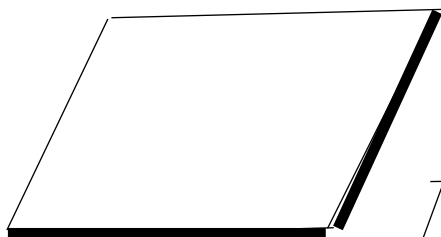

31-00-20 Alpine II



**Plastic
31-07
31-08**

**8 x 150 x 3000
8 x 150 x 2000**

Plastic ski skins

8 mm HPDE.

 32-01 Arctic Cat	 32-06 Arctic Cat
 32-00 Ockelbo	 32-11 Trapper, Nordik
 32-99 Safari, Scandic 380	 32-21B Formula, Snowexpert







This ski needs normal runner **MM277** and Carbide **MM147**
Ski skin 33-90 fits nice this blow moulded Skidoo ski

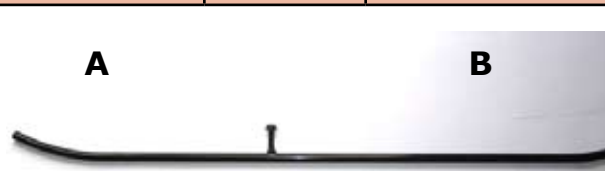
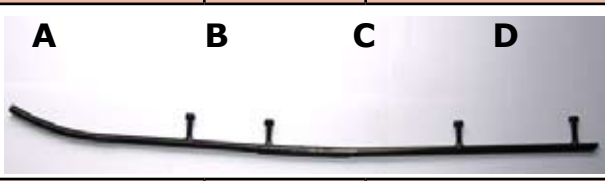
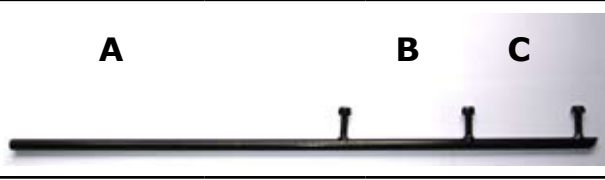
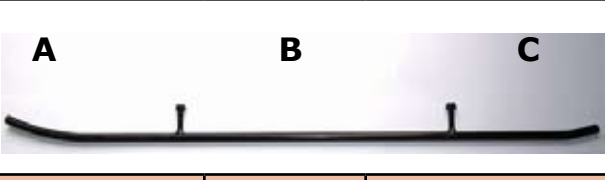
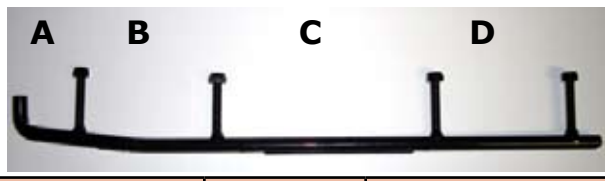
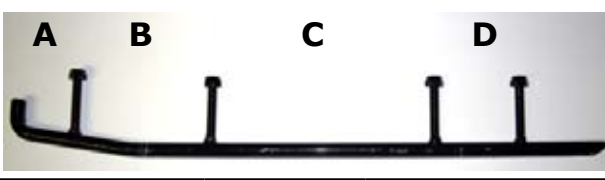
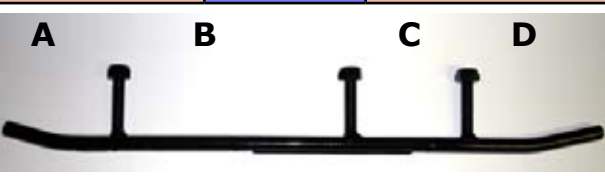

 32-61 Lynx	 32-41 Polaris 1993-
 32-51 Polaris -92, Ockelbo	 32-81 Yamaha Viking
 32-88 Yamaha Phaser 98-	 32-91 Yamaha V-max 94-

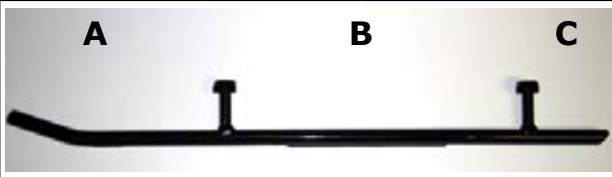
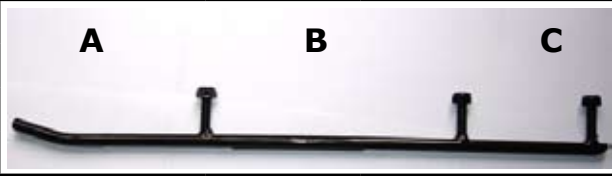
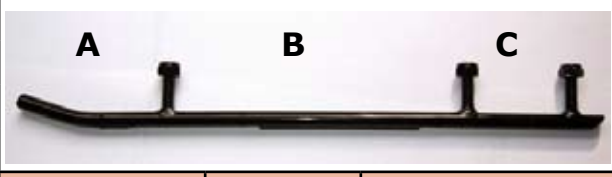
ARCTIC CAT

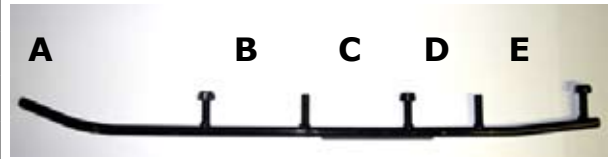
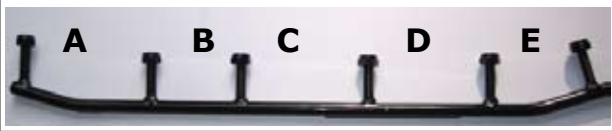
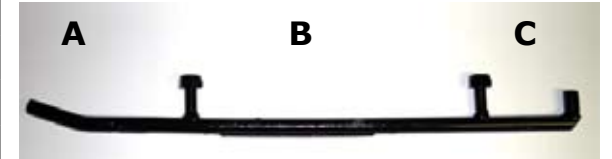
Gleitstäbe

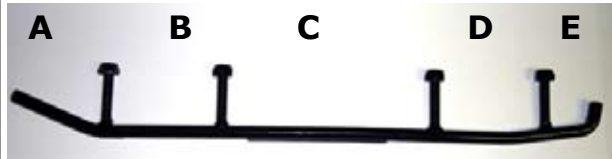

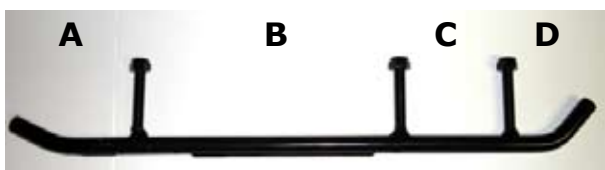
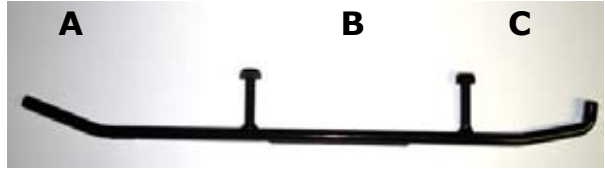

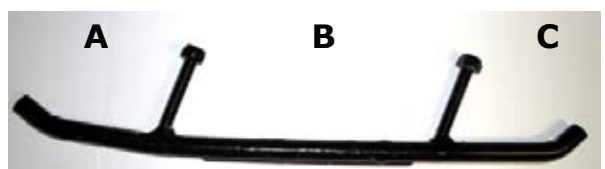
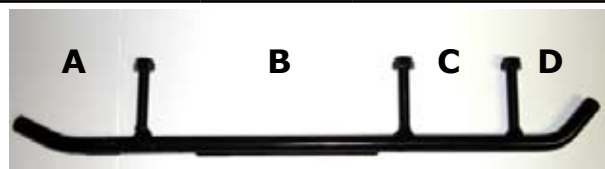
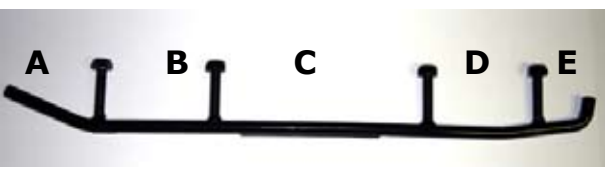
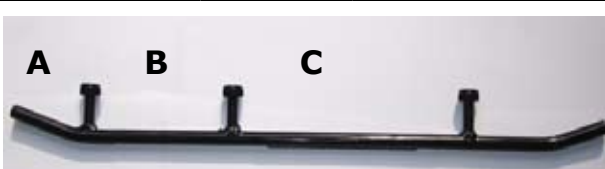
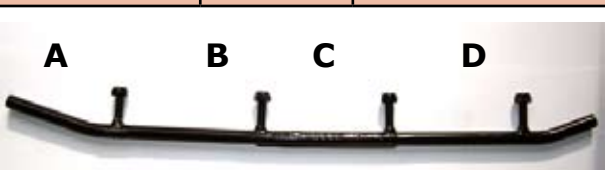

Normal	Racing	Carbide	L=Länge	A	B	C	D	E	
MM203		MM169	772	386	386	-	-	-	
			AKTIV: Alaska, Panther, Karibo 1984-1986, and also ARCTIC CAT: El Tigre 1980-84, Jag 1980-91, Panther 1980-89, Super Jag 1987-92 Trail Cat 1980-81, Pantera 1980-85						
MM205		MM170	776	343	433	-			
			Cheetah Tour 1987-91, Cougar 1987-91 El Tigre 1987-90, Jag AFS 1989-91 Manx 1991-, Pantera 1987-90 Panther 1990-91, Wild Cat 650 1988-90						
MM260		MM133	787	260	108	249	162		
			Ext Special 1992, Ext 580,Z 1993-94, Jag Special, Z 1992, Prowler Spec. 1992-94 Wild Cat 700 EFI 1992-94, ZR 440 1993-95 ZR 580,700 1993-95, Thunder Cat 1996						
MM210		MM173	610	356	127	114			
			Bear Cat 340,440 1995-99, Cheetah Tour 1992-94 Cougar 1992-97, Ext, EFI 1992-93, Manx 1992-93 Jag AFS DL 1992-93, Prowler 2-UP 1992-94 Pantera 1992-97, Panther 1992-93, Prowler 1991-96 Thunder Cat 1993-95 Puma 1991-97, Wild Cat EFI 1992						
MM261			791	236	380	193			
			El Tigre 1985-86 Cougar 1985-86 Cheetah 1986 Pantera 1986						
MM262		MM157	469	57	114	178	114		
			Plastic skis 1996-						
MM263		MM158	469	57	114	178	70		
			Plastic skis 2005-???						
SLP ski			SLP ski						
MM290	MM390	MM190	470	89	179	90	112		
			SLP ski Auf den Fotos ist die Front des Gleitstäbe auf der linken Seite, immer.						

Normal	Racing	Carbide	L=Länge	A	B	C	D	E	
MM242		MM189	470	170	235	65			
			Forest Fox 1999-, GL360, 250 1991-93, GL 2300 -90 GL 3300 1989-90, GL 3900, LTS 1991-92 GLS 3900 1989-90, GLX 5900, LTS 1991-93 GL Sport, LTS 1991-92, Ranger 1993						
MM230		MM187	550		235				
			GL 250. 250S 1986-89, GL 3900 1983-88 GL 5900 1983-90 535, 650 1983-87 640 1988						
MM240		MM188	450		228	81			
			GLS 3300 1986-89, GLS 3500 F/C 1990-93 GLS 3600 L/C 1990-91, Cobra 1992-93 3800 Rave, Ultra, Cobra Touring, Rave , Cobra Racing, Enduro 1993						
MM241			450		219				
			230, 250, 650 1989-93						
MM265		MM154	660	215	110	114	80	122	
			G-type Rave 1997-99 Enduro 600						
		MM153	530	120		115	110	80	
			G-type Racing 1998- Sport XR 98						
		MM152	440	130	228	77			
			G-type 1997-99 Enduro 500						
MM250		MM193	625	321	241	63			
			Ranger short steel ski of Skidoo 2000-						
MM279		MM146	537	90	103	190	103	54	
			FLEX plastic ski 2000- Fit also Skidoo						

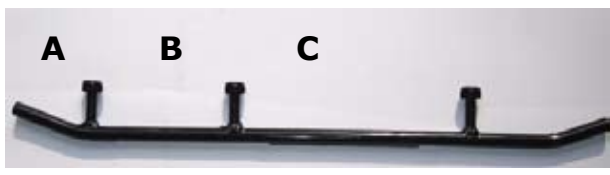
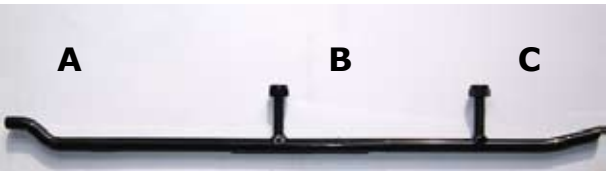
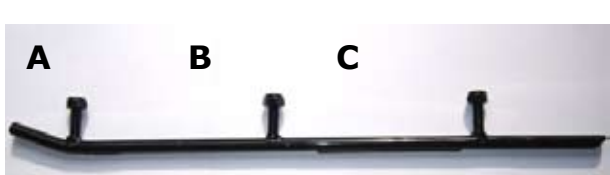
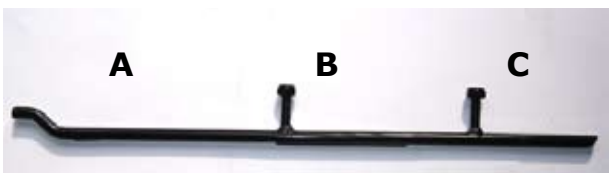
Normal	Racing	Carbide	L=Länge	A	B	C	D	E	
MM277		MM147	400	87	177	75	60		
			Plastic, Camoplast ski 2003- Also for Skidoo and Polaris						
MM243	MM386	MM186	520	210	192	121			
			ADJ ski, CTRL ski 2003- The rear is bent for easier assembly of ski and plastic skis						
MM255			520		192				
			ADJ ski with three bolts						
SKI-DOO									
MM274		MM144	335	89	160				
			Pilotti ski/ Skidoo, narrow and wide						
MM277		MM147	400	87	177	75	60		
			Plastic, Camoplast ski 2003- Also for Skidoo and Polaris Skandic 380-550 2003-						
MM279		MM146	534	84	103	190	103	54	
			Plastic ski FLEX 1997- Also Lynx						
		MM141	445	54	95	222			
			Formula 583 1998 Formula III 600, 700 1997-99 Formula Mach I, Z 1997-99, Formula Z 1997-99 G-Touring 583, 670 1997-99, Summit 1997-99						
		MM142	502	90	126	110	116	60	
			MXZ 440, 583, 670 1996-99						

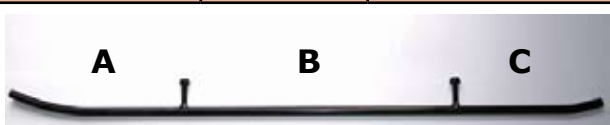





SKI-DOO



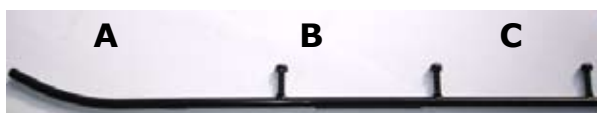
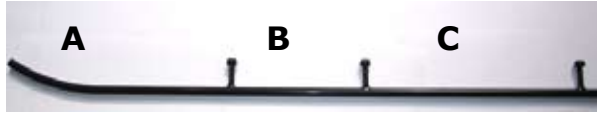

Gleitstäbe

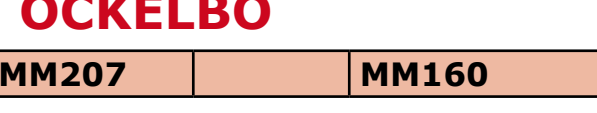
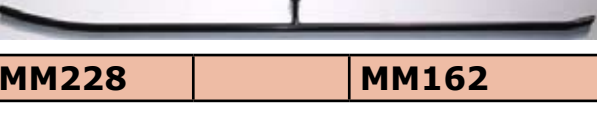
Normal	Racing	Carbide	L=Länge	A	B	C	D	E	
		MM143	495	54	120	196	115		
			Formula III 1985-96, Formula Mach Z 1985-96						
			Formula MXZ 1993-95, Formula Z 1994-96						
			G-Touring 583, 670 1993-96						
			Summit 1994-96						
MM229			602	248	176				
			Formula SP DL 1985-86, Tundra 1985-97						
			Safari 377, 447, 503 1984-88						
			Safari, Saga, Scout 1989-92						
			Skandic 377, 503 1986-87						
MM216		MM163	602		170	170	99		
			Formula Mach I 1989-94, Formula SS 1995-96						
			Formula MX, XTC 1985-95						
			Formula Plus, XTC 1985-93						
			Formula ST, STX 1994-96, Grand Touring 470 -95						
Safari DL, 503 Rally 1993-94, Safari GLX, LCE, L 1990-94, Skandic II 377, 503 92-94									
MM275		MM145	545		178	114			
			Blizzard 1978-84, Nordik 1981-83						
			Everest 1974-83, Olympique 1976-79						
			Skandic 277, 377 1982-85						
			TNT 1973-78						
MM215		MM176	527	238	177	112			
			Safari Cheyenne 1989-91						
			Alpine II 1991-95						
MM211		MM174	483	162	178				
			Citation 1980-91						
			Elan 1971						
MM250		MM193	625	321	241	63			
			Formula 500, DL 1996-99						
			Formula 583 1996-99, Formula S, SL, SLS 95-99						
			G-Touring 500 1996, Scandic 380, 500 1995-						
TRAPPER, NORDIK									
MM215		MM176	527	238	177	112			
			Nordik 300-377						
			Nordik 500-600						
			Nordik 540-600 SL						
MM227		MM171	480	250	148	82			
			Nordik 500 PSS,						
			Nordik 550						

POLARIS

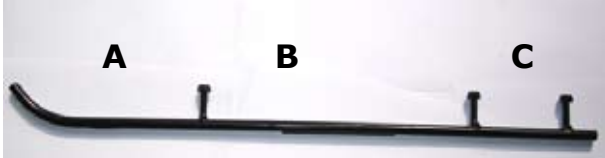
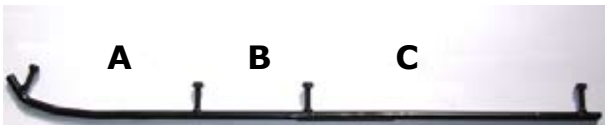
Gleitstäbe

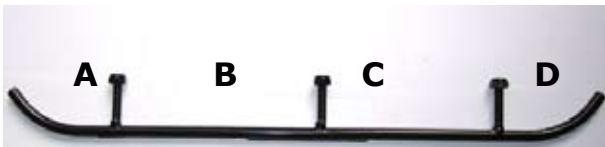
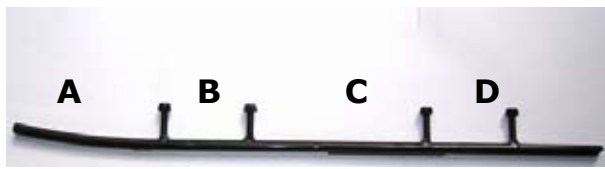
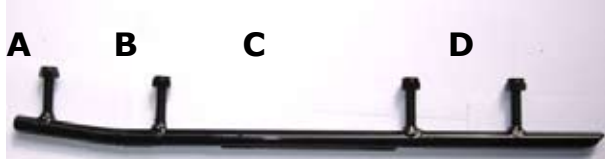
Normal	Racing	Carbide	L=Länge	A	B	C	D	E	
MM202	MM348	MM148	722	180	160	178	178		
			Plastic skis 2007- Replaces original MM348 racing runner						
MM270		MM149	680	310	178	178			
			Plastic skis 1997- Indy RMK 700, Indy XC 400, Indy XCR 600 1997- Indy Storm, Indy Ultra 1997-						
MM206		MM159	673	317	178	178			
			All mod. 1988-98 All with steel skis 1998-99 Indy Sport 1987						
MM209		MM177	813	317	178	255			
			Indy 400, 600, Trail, Longtrack, Sprint SS, Star, Startrack 1986-87						
MM208			813	405	408				
			All makes 1971-82 Indy 600, 400, Trail, Longtrack, Sport, SS, Star, LT 1983-85						
	MM398								
			Polaris Gripper ski						
<h2>OCKELBO</h2>									
MM207		MM160	800	395	405				
			All mod. -1986 Ockelbo						
MM228		MM162	450		270				
			All mod. 1987- Ockelbo						
<h2>YAMAHA</h2>									
MM219			578	57	184	311			
			BR 250 1982-94 ET 250, 300, 340 1977-84 SR 540 1980-84 SRX 440 1976-80						

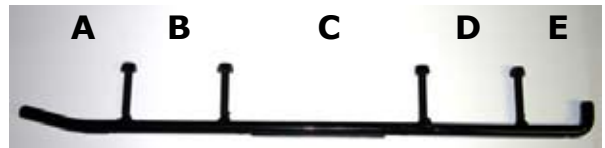
Normal	Racing	Carbide	L=Länge	A	B	C	D	E	
MM217		MM138	621	60	174	268			
			ET 340 1985-88						
MM224		MM164	635	216	292	101			
			Exiter 570 1987-90						
			SR 540, V-MAX 540 1987-91						
MM280		MM137	768		140	360			
			BR 250 T, TS 1984-98						
			ET 340 T, TR 1981-88						
			ET 400 T, TR 1989-91						
			EX 340, 440 1977-81						
MM232		MM166	663	57	183	210	101		
			CS 340 1990-99, Exiter II 570, SX 1991-93						
			Phazer II, E, ST 1984-99, SR 540 1985-86						
			V-Max 540 1983-86, Viking II 540 1988-92						
			XLV 540 1985-91						
MM235		MM175	604		181	210			
			ET 410 TR 1992-99						
			Viking II 540 E 1993-99						
			Venture 480 1991-99						
MM251		MM194	608	159	90	185	90		
			V-Max-4 1992-94						
			Venture 500,600,700 1995-96						
			V-Max 500, 600, 700 1994-96						
			V-Max 800 1995-97						
MM281		MM136	419		82	176	59	62	
			V-max 500, 600, 700 1997-99						
			Venture 500,600,700 1997-99						
MM282		MM135	475		124	160	118		
			SRX 600, 700 1998-						
MM239	MM339	MM139	530	100	90	180	90	70	
			RX, RX-1 2002-						

Powerbloc 80



Wartungsfreie Kupplung jetzt für leistungsstarke flüssigkeitsgekühlte Motoren Diese Kupplung nicht Ärmel, Hebel oder andere Teile, die beschädigt werden könnten. Sehr zuverlässig. Auf der Kupplung installiert die ursprüngliche Anlasserzahnkranz werden. Clutch geliefert vorkalibrierten

Clutch ist auf den Verkauf in den Anfang an des Jahres 2008.



Polaris

Sie können alle Kalibrierungen auf unserer Webseite finden Sie unter: [www.teolehtimaki.fi/spare parts catalogue](http://www.teolehtimaki.fi/spare_parts_catalogue)

15-84	Alle Motoren, 488 cc	1989-
15-84	600 cc 2-cyl	1997-07
15-84	600 cc 3-cyl	1996
15-84	700 cc 2-cyl	1997-06
15-84	800 cc 2-cyl	2000-05
15-84	750 cc 4-tahti turbo, 4-stroke turbo	2006-



Polaris Kegel:
Left, Fuji Motor ab. 28 mm lang
Richtig, USA-Motor, ab. 33 mm lang

Die Kupplung 15-84 fits alle Polaris macht, auch Fuji. Der Winkel des Kegels ist das gleiche, es ist mehr.

Hinweis: Fuji Motor Kupplungen nicht auf die Motoren der USA fit

Arctic Cat

Kleine Kegel		
15-85	Alle weniger als 700 ccm Motoren	
Big Kegel auf die folgenden Motoren aus 2003		
15-86	599 3D 2-cyl. 114 hp 31 mm	2003-
15-86	658 cdi 3-cyl. 110 hp 4-stroke, 31 mm	2003-
15-86	698 3D 2-cyl. 140 hp 31 mm	2003-

Skidoo & Lynx

15-81	Rotax 453	MXZ 440 LC X
15-81	Rotax 593, 500SS	1999-2008
15-81	Rotax 693 2-cyl	1999-
15-81	Rotax 699 3-cyl	1996-
15-81	Rotax V-810	2007-
15-81	Rotax V-1000	2003-
15-81	Rotax V-1200	2009-
15-82	Rotax 493, 494	1996-
15-82	Rotax 593HO,600 SDI	2003-2004
15-82	Rotax 670	1993-
15-84	Rotax 582, 583, 643	1993-

Makes 15-81 und 15-82, große Kegel. Ohne Zahnkranz beide macht, kann verwendet werden. Aber 15-84, kleine Kegel.

Yamaha

15-83	500, 494 cc	1994-2001
15-83	600 cc 2-cyl	1994-1999
15-83	600 cc 3-cyl	1999-2002
15-83	700 cc	1996-2002
4-tahti, 4-stroke		
15-83	499 cc 80 hp	2007-
15-83	973 cc 120 hp	
15-83	998 cc Rx 1	2003
15-83	1049 cc	2008-



P80 Federn

Number		N min/ 72 mm	N max / 45 mm	Länge	A dia.
15-91	0451-1135	900	1300	138,0	5,50
15-92	0451-1136	900	1600	109,0	6,00
15-93	0451-1132	810	1150	143,0	5,50
15-94	0451-1134	742	1612	95,0	6,00
15-95	0451-1109	300	1100	82,0	6,00
15-96	0451-1114	400	900	95,0	5,50
15-97	0451-1133	800	1300	121,0	5,50
15-98	0451-1113	400	700	111,0	4,90
15-99	0451-1128	700	900	176,0	4,75



Abzieher für
P50, P80, TRA
Part number: **18-212**

P50 Kupplung

Die Teilenummer ist blau

Alle Kalibrierungen sind auf den Seiten:

www.teolehtimaki.fi/spare_parts_catalogue

Unsere Homepage ist häufig aktualisiert, um die meisten up-to-date Informationen über unsere Produkte zu gewährleisten.

Number	S4B	P50 number	CVTech	PTO	Belt	x	Use
15-01	6513B	0403-0001		3,65	31,2		15-02
15-02	5913B	0403-0002		2,50	31,7		15-02
15-03		0403-0003	15-0147C	8,77	34,8	8	15-03
15-04		0403-0004	15-0148C	8,77	34,8	8	15-04
15-05	0513B	0403-0005		11,5	33,3	6	15-05
15-06	8113B	0403-0006	15-0149C	6	34,9		15-06
15-07	5413B	0403-0007		7,5	34,9		15-06
15-09	9513B	0403-0009		11,5	34,9	6	15-09
15-10	9713B	0403-0010		5	33,3		15-10
15-11	9213B	0403-0011	15-0151C	1,5	34,9		15-11
15-18	9113B	0403-0018	flange	4,99	34,9		15-18
15-19	9613B	0403-0019		8,58	34,9	6	15-19
15-20		0403-0020		8,77	34,8	8	15-03
15-21	9313B	0403-0021	flange	0,06	34,9		15-21
15-22	3113B	0403-0022	flange	0,06	32,7		15-22

X = srew for ring gear, 6 mm or 8 mm

P50 Federn

Number	CVTech	N min /	N max /	Länge	A dia.	Note
		72 mm	45 mm	mm	mm	
15-52	0151-0002	618 / 637	1050 / 1115	110 / 108	5,26 / 5,50	+ 1
15-51	0151-0003	730 / 730	987 / 1056	158 / 132	4,88 / 5,50	+ 1
15-55	0151-0004	728 / 708	1110 / 1056	134 / 127	5,26 / 5,50	
15-53	0151-0006	500 / 499	1070 / 1142	095 / 93	5,71 / 6,00	
15-54	0451-1118	500 / 501	700 / 832	148 / 114	4,50 / 5,50	+ 1
15-55	0451-1129	700 / 708	1100 / 1056	123 / 127	5,26 / 5,50	
15-56	0451-1137	595 / 604	852 / 929	135 / 122	4,88 / 5,50	+ 1

Wenn der Motor bei voller Drehzahl läuft, wird die Federrate etwas höher auf der Blue Spring als die Federrate der CVTech Frühling. Die Kalibrierung kann durch Zugabe eines Shim in jedem Block eingestellt werden. Beachten Sie, dass eine Scheibe zu 100 RPMs entspricht.

Wenn das Engagement RPM unterscheidet sich von der Nenndrehzahl des Motors immer, ob im Frühjahr Einstellung und die Ausrichtung der Powerline.

ALT-clutch



15-1213A



15-0513A



15-2913A



15-3113A



15-1713A

Arctic Cat		p/n	Federn	shims	weight
All models	1970-80	1213	ask	ask	
Jag 4000	1981	1213	3	10	
Pantera 5000	1977-81	1213	3	12	
Panther 4000	1977-81	1213	3	9	
El Tigre 5000	1978-80	1213	3	12	
Trail Cat 4000	1980-81	1213	3	10	
Ski-Doo					
Alpine640	1969-75	0913	3		150
Alpine640	1975-82	0613	3		150
Citation 4500/SS	1980-83	0513	1	9	
Citation LS/E	1985-91	3913	1	12	
Elan 250/247cc	1971-96	1013	1	12	
Elan 248-294 cc	1973-79	1013	1	4	
Elite 464 cc	1975-79	0513	1	12	
Everest TNT	1975-79	0513	1	4	
Everest 444/464	1978-83	0513	1	12	
Everest 500	1980-83	0513	1	9	
Olympic mod	1969-75	1013	ask	ask	ask
Skandic 277	1983	3913	2	6	
Scandic 377 / R	1982-87	0513	1	9	
Tundra LT / LTS	1985-92	3913	1	12	
Skidoo models	1965-80	kysy	ask	kysy	ask
Polaris					
Polaris models	1970-80	2815	ask	ask	ask
Star, L/T	1983-87	2815	1	4	
Yamaha					
BR 250	1982-84	2913	1	13	
BR 250 TS, T, LT	1984-01	3113	1	12	
ET 250	1977-81	1713	1	4	
ET 300	1979-84	2913	1	4	
ET 340E, T, TR	1978-88	2913	1	6	
ET 400T, TR	1989-91	2913	1	11	
EC 340 338 cc	1981-88	2913	1	6	
EC 540 535 cc	1979-82	2913	1	12	
EX 340 338 cc	1976-78	2913	1	6	
EX 440 433 cc	1976-81	2913	1	13	
Phazer 433 cc	1984-89	3113	1	13	
SRV 540	1984-91	3113	1	12	
SRX 440	1976-80	3113	1	13	
SS 440	1980-85	3113	4	13	
STX 340	1976-77	2913	1	6	
STX 440	1976-77	2913	1	13	
XLV 540	1985-90	3113	1	12	
Motoski					
Motoski	1973-80	ask	ask	ask	ask
Futura 400, E	1977-79	0513	3	8	
Futura 444, LC	1978-79	0513	3	7	
Futura 464, RV	1980-83	0513	3	10	
Futura 500	1980-83	0513	3	10	
Mirage 1.	1980-83	0513	2	10	

ALT-Kupplung



15-3913A



16-11



16-06



16-09



16-08



16-07



16-02

Lynx		p/n	Federn	shims	weight
L 320 295 cc	197?-80	1213A	1	9	
L 520 295 cc	197?-83	1213A	1		60
L 330 340 cc	197?-80	1213A	1	8	
L 535 440 cc	197?-79	1213A	1		60
L 635 440 cc	197?-79	1213A	1		90
GLX 503 cc	1981-82	1213A	1		60
GLX / 5900	1984-93	0513A	1		60
L 535 503 cc	1981-83	1213A	1		60
L 535 503 cc	1984-87	0513A	1		60
L 635 / XL	1981-83	1213A	1		90
GL 3300 377 cc	1982	0513A	2	12	
GL 3900 377 cc	1982-91	0513A	2	12	
L 650 503 cc	1982-92	0513A	1		90
L 250, S 253 cc	1985-91	0513A	2	6	
GL 3300 S 503 c	1984-89	0513A	1	7	
GL 3300 377 cc	1989-90	0513A	1	12	
Ockelbo					
Oc 300	1978-80	3113A	2	14	
Oc 600-1	1978-80	3113A	2	14	
Oc 600-2	1979-81	0513A	2		60
Oc 8000	1980-88	0513A	2		90
Oc 6000	1980-88	0513A	2		60
Oc Poro	1983-85	0513A	2	6	
Oc 4000	1982-83	0513A	2	7	
Oc 5000	1983-88	0513A	2		60
Oc 3500	1986-88	0513A	2	6	
Oc 4500	1986-88	0513A	2		60
Fighter	1988	0513A	2	10	
Trapper	Nordik				
Trapper 5000	1984-	0513A	1	10	
Trapper 6000	1984-	0513A	1		90
Nordik 300, R	1988-	3913A	1	10	
Aktiv					
Aktiv models	1976-82	1213A	ask	ask	ask
Aktiv models	1983-	0513A	ask	ask	ask
Terri 30					
Terri	1975-	0513A	5		

ALT Federn

Number	CVTech	Länge mm	min. kg	max. kg
19-12	X-5243212	70	11	171
19-02	X-5243300	76	43	182
19-01	X-5243302	79	53	192
19-03	X-5243304	83	69	209
19-04	X-5243306	86	85	211
19-05	X-5243308	89	94	213
19-06	X-5243310	92	104	216
16-20	X-5218300	76	30	127



**S4B-Kupplung,
Tundra II , 15-
9713B**



18-130



18-030

S4B Ersatzteile



18-100



17-050



17-051



**18-060
18-090**



**18-140
18-200**



18-120



17-090



16-07



16-08



17-040 Cap

Driven pulley, Ersatzteile



**14-16
cam**



**14-10
shim**



**Länge 39 mm
dia 38 mm
outer d. 44,5 mm**

**14-08
bearing**



**14-15
cam 14- makes**

P50 Ersatzteile



19-100



19-120



**19-170 screw
19-171 polaris
19-140 shim
17-112 nut
18-160 washer**



19-050



19-130



19-030



16-08



16-07

Driven pulley

Vuosi Year	Malli, make, modelle	Ro- tax	osa # part #
	Terri 30, 2020		14-6038
	Trapper, Ockelbo		14-6024
1984-93	535, 5900 GLX, 650	503	14-6028
-93	GL 250	253	14-6028
-93	360, Ranger, GL3300	377	14-6028
1994-96	360 S, Ranger	377	14-6041
-96	Ranger 380, Fox, Light	380	coming
1994-96	GLX 5900FC, 650 S	503	14-6041
1994-96	GLX 5900 LC	493	14-6041
1997-98	Ranger 380,	380	coming
1997-98	Fox, S, Light Touring	380	coming
1997-98	GLX 5900 FC, 6900	503	14-6032
1997-98	GLX 5900 LC	493	14-6032
1999-03	GLX 5900 FC	503	14-6032
1999-04	6900	503	14-6032
1999-??	Fox 440	447	coming
1999-00	GLX 5900	493	14-6032
2000-	Ranger 500 FC	503	14-6032
2000-	Ranger 500 LC	493	14-6032
2001-	5900 ST	593	14-6032
2004-	SUV 550, Ranger	550	14-6032
2004-	6900	550	14-6032
2004-	SUV 600, ST 600	593	14-6033
2004-	5900 Yeti V-1000		14-0021
2005-	5900 Yeti 600 HO SDI	593	14-6021
2006-	SUV 600, Ranger 600	593	14-6021
2007-	TUV 600 HO SDI	593	14-6021
2007-	Yeti, Yeti Pro V-800	800	14-6021

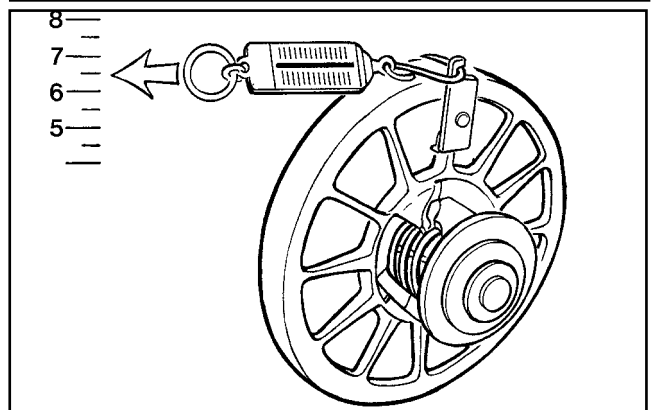

Einstellen

Wann immer Sie eine neue Kupplung oder Reparatur der alten, immer daran denken, die Spannung und den Zustand des Schecks Antriebsscheibe Frühling. Sehr oft wird der Frühling ist schwach und unfähig, richtig zu erfüllen. Wenn die Feder in der Antriebsscheibe ist schwach, erlaubt es die Kupplung zu früh verschieben und bewirkt, dass der Motor zu laufen ineffizient. Beim Austausch oder Anziehen der Feder, immer saubere Teile und kein Fett verwenden.

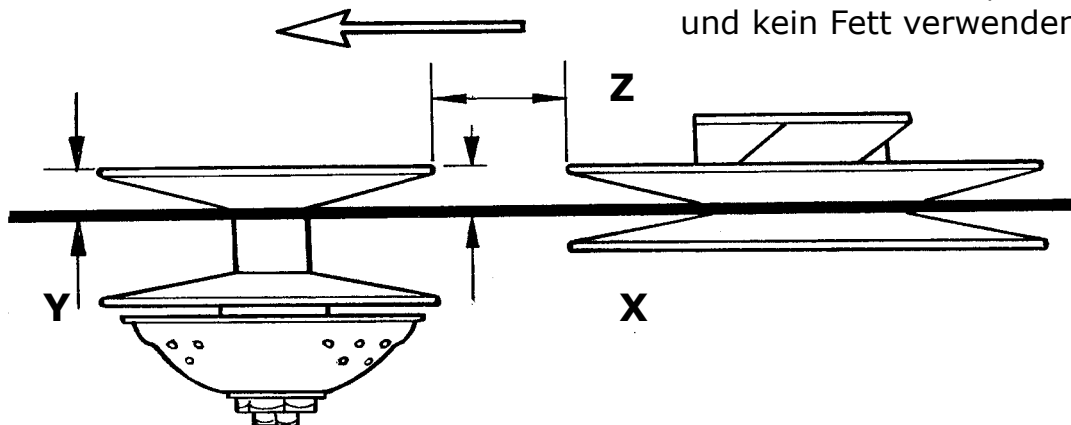

Powerline

Überprüfen Sie die Powerline mit 12 mm dicken Eisenstange. Wenn es keine Gummi stopfen Abstellen des Motors zu drehen, wenn mit dem Gas, dann Y muss 1,0 - 1,5 mm größer als X Beachten Sie auch, dass aufgrund der geringeren clutch, ändert sich der Abstand Z in Service-Handbuch nicht vorhanden . Es ist etwas anderes, aber der Unterschied ist akzeptabel.

Arctic Cat

Kurbelwellenlager

2-CYL F/C	Years	MGT	CENTER	PTO
340 F/C inj	1987-94	83350A (DG2555)	83350A (DG2555)	83519D x 83519D
440 F/C	1980-06	83519D	83519D x 83519D	83519D x 83519D
370-Z440	1999-08	83519D	83519D x 83519D	83519D x 83519D
440 F/C	1988-00	83519D	83519D x 83519D	83519D x 83519D
440F/C Snopro	2002-03	83519D	83519D x 83519D	OEM 3006-096
500 F/C	Kaikki	83519D x 83519D	83519D x 83519D	83519D x 83519D
570 F/C	2002-05	6306N9C4 /	6306N9C4 x 2	35NQ5528W11
2-CYL L/C				
440 L/C		83519D x 83519D	83519D x 83519D	OEM N/A
440 L/C	1987-89	83519D x 83519D	83A073B x 83A073B	OEM N/A
440 L/C ZR	1995	83A073-9	83A073B x 83A073B	40NQ 6430W1
440 L/C ZR	1996-00	83A073-9	83A073B x 83A073B	40NQ 6430W1
440L/C Snopro	2003-04	306/1DYR1W	83B551A 30mm x 2	40NQ 6430W1S
F-5	2003-07	306/1DYR1W	83B551A 30mm x 2	40NQ 6430W1S
5-600ZR T-	1998-02	83A073-9	83A073B x 83A073B	40NQ 6430W1
530 L/C		83519D	83A073B x 83A073B	OEM N/A
550 L/C	1991-92	83A073-9	83A073A x 83A073B	40NQ 6430W1
550 L/C	1993-05	83A073-9	83A073A x 83A073B	40NQ 6430W1
580 L/C	1993-05	83A073-9	83A073A x 83A073B	40NQ 6430W1
600 ZR	2000-04	6306/4DYR1	83B551A 30mm x 2	40NQ 6430W1
650 L/C W-C	1988-90	83B551A 35mm	83B551A 35mm x 2	OEM N/A
700 L/C	1991-93	83B551A 35mm	83B551A 35mm x 2	40NQ 6430W1
700 L/C	1994-97	83B551A 35mm	83B551A 35mm x 2	40NQ 6430W1
F6-F7	2003-05	22075/1DYR1W	83B551A 35mm x 2	40NQ 6430W1S
800-900 ZR	2000-06	307/1DYR1W10	6307R/1DYR x 2	3208/1DW11CA
3-CYL L/C				
600 L/C ZRT	1995-02	83A073B	6207R9 x 83A073B x2	40NQ 6430W1
800-900 L/C	1993-00	6306/4DYRI	6209/1DRIN X 4	6209/1DRIN X 2
1000 L/C	1998-02	6306/4DYRI	6209/1DRIN X 4	6209/1DRIN X 2

Part number Dimensions

Part number 35-	Dimensions	Parts number 35-	Dimensions
22075/1DYR1W	35 X 75 X 23	DG2555	25 X 55 X 15
3208/1DW11CA	40 X 83 X 30	35NQ5528W11	35 X 55 X 28
306/1DYR1W	30 X 75 X 19	40NQ6430WI	40 X 64 X 30
307/1DYR1W10	35 X 83 X 21	40NQ6430W1S	40 X 64 X 30
6209/1DRIN	45 X 90 X 19	83519D	30 X 65 X 16
6207R9	35 X 72 X 17	83A073-9	30 X 72 X 19
6306/4DYR1	30 X 72 X 19	83350A	25 X 55 X 15
6306/N9C4	30 X 72 X 19	83B551A 30 mm	30 X 75 X 17
OEM 3006-096		83B551A 35 mm	35 X 75 X 17

Rotax = Lynx, Skidoo Kurbelwellenlager

1-CYL F/C		MGT	CENTER	PTO
247 F/C ELAN	1985-96	83464C (6305 C4)		83464C (6305C4)
253 F/C	1985-92	6206 GPC4		6206 GPC4
277 F/C	1980-84	83464C		6306 PC4
277 F/C	1993-08	6206 C4		6306 PC4
2-CYL F/C				
377-447 Kärjet	1980-81	6207 GPC4	6305 NRC4 x 2	6207 GPC4 x 2
377-447 Nippon D	1982-89	6207 GPC4	6305 NRC4 x 2	6206 GPC4 x 2
377-447 F/C	1990-96	6207 GPC4	6207 GPC4 x 2	6207 GPC4 x 2
377-447 F/C	1997-05	6207 GPC4	6207 GPC4 x 2	6207 PC4 x 2
503 Kärjet	1979-81	6207 GPC4	6305-NRC4 x 2	6206 GPC4 x 2
503 Nippon D	1982-89	6207 GPC4	6305 NRC4 x 6206 GPC4	6206 GPC4 x 2
503 F/C	1990-96	6207 GPC4	6207 GPC4 x 2	6207 GPC4 x 2
503 F/C	1997-03	6207 GPC4	6207 GPC4 x 2	6207 GPC4 x 2
550 Top needle	2003-05	6207 GPC4	6207 PC4 x 6207 PC4	6207 GPC4
640 F/C	1970-82	6306 NRC4	6306 NRC4	6306 NRC4
2-CYL L/C				
440 MXZ-X, 500	2000-05	6206 PC4 x 2	6206 PC4 x 2	6207 PC4 x 2
444 L/C	1977-79	6206 GPC4	6305 NRC4 x 2	6206 GPC4 x 2
454 L/C	1995-98	6206 PC4 x 2	6206 PC4 x 2	6207 PC4 x 2
462 L/C SP-SS	1984-86	6206 GPC4	6305 NRC4 x 6206 GPC4	6206 GPC4 x 2
467 L/C	1985-95	6206 GPC4 x 2	6305 NRC4 x 6206 GPC4	6207 GPC4x 2
494 L/C T-Crank	1996-00	6206 PC4 x 2	6206 PC4 x 2	6207 PC4 x 2
500 L/C	2003	6206 PC4 x 804551	6206 PC4 x 2	FAG x 6207 PC4
532-536-582-583	1985-99	6206 GPC4 x 2	6305 NRC4 x 6206 GPC4	6207 NRC4 x 2
600 L/C C-Seal 63	1999	6206 PC4 x 2	6206 GPC4 x 2	6207 PC4 x 2
600 L/C C-Seal 66	2000-02	6207 PC4 x 2	6206 GPC4 x 2	FAG x 6207 PC4
500SS, 600 C-S 66	2003-07	804551 x 6206 PC4	6206 PC4 x 2	FAG x 6207 PC4
600 MXCX RS	2008	6207 PC4 x 2	6207 PC4 x 2	804662E x 6208 PC4
600 HO SDI Key12	2004-07	FAG x 6207PC4	6207 PC4 x 2	6208X x 804662E
600 HO C-Seal 76	2003-05	FAG x 6207PC4	6207 PC4 x 2	FAG x 6207 PC4
600/593 E-Tec	All	FAG x 6207PC4	6207 PC4 x 2	6208X x 804662E
617-643 L/C	1991-92	6206 GPC4 x 2	6305 NRC4 x 6206 GPC4	6207 GPC4 x 2
670 L/C	1993-97	6206 PC4 x 2	6206 PC4 x 2	6207 GPC4 x 2
670 L/C	1998-99	6207 PC4 x 2	6206 PC4 x 2	6207 PC4 x 2
700 L/C C-Seal 79	1999-00	6207 PC4 x 2	6207 PC4 x 2	6208 PC4 X 2
700 L/C C-Seal 76	2000	6207 PC4 x 2	6207 PC4 x 2	6208 PC4 x 2
700 L/C Mgt seal	2001-02	FAG x 6207PC4	6207 PC4 x 2	6208 PC4 x 2
700 L/C C-Seal 76	2003-05	FAG x 6207PC4	6207 PC4 x 2	6208 PC4 x 804662E
800 L/C	2000-03	FAG x 6207PC4	6207 PC4 x 2	6208-PC4 X 2
800 L/C HO, R,	2003-07	FAG x 6207PC4	6207 PC4 x 2	6208X x 804662E
1000 L/ HO	2005-07	804662E x 2	6208 PC4 x 2	804662E x 2
3-CYL L/C				
600 L/C	1995	6208-PC4	6206 PC4 x 4	6208 PC4 x 2
600 L/C	1996-97	6208-PC4	6206 PC4 x 4	6208 PC4 x 2
600-700 L/C CK3	1998-00	6208-PC4	6206 PC4 x 4	6208 PC4 x 2
779 L/C	1993-96	6208-PC4	6207 GPC4x 4	6208 PC4 x 2
809 L/C	1997-03	6208-PC4	6207 PC4 x 4	6208 PC4 x 2

Rotax

Part number

Dimensions

Part number 35-	Dimensions	Parts number 35-	Dimensions
6305 C4 = 83464 C	25 X 62 X 17	6207 C4	35 X 72 X 17
6305 NRC4	25 X 62 X 17	6207 PC4	35 X 72 X 17
6306 NRC4	30 X 72 X 19	6207 GPC4	35 X 72 X 17
6206 C4	30 X 62 X 16	804551 = 6206 GSPC4	30 X 62 X 18/19
6206 PC4	30 X 62 X 16	804662E = 6208 GSPC4	40 X 80 X 21
6206 GPC4	30 X 62 X 16	6208 PC4	40 X 80 X 18
FAG = 804661BL178	35 X 72 X 17/18	6208X = 6208X28YR1N	40 X 80 X 23
FAG = 6207 GSPC4	35 X 72 X 17/18	6208 GSPC4	40 X 80 X 21

Yamaha

Kurbelwellenlager

1-CYL F/C		MGT	CENTER	PTO
250 ET		6206 C4		6306 NRC4
250 BRAVO		6305 H/INDY		6306 N9C4
2-CYL F/C				
300-340 F/C ET		83464-C	83548D-9	6306 N9C4
400-410 F/C		83464-C	83548D-9 x 83548D-9	OEM N/A
440 SS		83548D9		DG3278JISO x 2
485 F/C	1984-98	DG3268B	DG3268-B x DG3268-B	83A779 x 2
500 F/C	1999-02	DG3268B		83A779 x 2
535-540 F/C VK		83548D9	83548D-9 x 83548D-9	DG3278JISO x 2
2-CYL L/C				
500-570-600cc	1987-96	83B207		
500-600 L/C	1997-	83B207		
3-CYL L/C				
700 L/C SX	1997	62/32GPC4 x 2	62/32GPC4 x 2 x OEM N/A	OEM N/A
600-700 L/C SX	1998-06	OEM N/A	OEM N/A	OEM N/A
600-700 L/C SRX	1998-99	OEM N/A	OEM N/A	OEM N/A
600-700 L/C SRX	2000-02	OEM N/A	OEM N/A	OEM N/A
700 L/C VIPER	2002-06	OEM N/A	OEM N/A	OEM N/A
4-CYL L/C		LEFT	CENTRE-GEAR CENTRE	RIGHT
750 / 8AX-11401	1992-94	6206PC4	6206PC4 x 4 x 6305GPC4	OEM N/A
750 / 8AX-11402	1992-04	6206PC4	6206PC4 x 4 x 6305GPC4	83464C
800 / 8BU-11401	1995-97	6206PC4	6206PC4 x 4 x 6305GPC4	OEM N/A
800 / 8BU-11402	1995-97	6206PC4	6206PC4 x 4 x 6305GPC4	OEM N/A

Part number

Dimensions

Part number 35-	Dimensions		Parts number 35-	Dimensions
6206 C4	30 X 62 X 16		83464C	25 X 62 X 17
6206 PC4	30 X 62 X 16		83A779	32 X 78 X 19
6305 H/INDY	25 X 68 X 17		83548D-9	32 X 62 X 16
6306 NRC4	30 X 75 X 19		83B207	32 X 72 X 30
6206 N9C4	30 X 72 X 19		DG3268-B	32 X 68 X 16
62/32 GPC4	32 X 65 X 17		DG3278JISO	32 X 78 X 16,5

Polaris Kurbelwellenlager

1-CYL F/C		MGT	CENTER X 2	PTO
250 F/C	1985-95	6206 C4		6206 C4 x 2
2-CYL F/C				
340 F/C Injection	Kaikki	6206 C4	6007 PC4 x 2	6206 GPC4 x 6206 PC4
440-500 F/C		6206 PC4	6206 PC4 x 2	6206 GPC4 x 6206 PC4
440 XCF-550 F/C	1998-07	5206 S9	6206 PC4 x 2	6207 GPC4 x 6207 PC4
2-CYL L/C				
440-500L/C		6206 PC4	6206 PC4 x 2	6206 GPC4 x 6206 PC4
440 L/C XCR only	1994-95	6206 PC4	6206 PC4 x 2	6206 GPC4 x 6206 PC4
440 L/C XCR	1996-97	6206 PC4	6206 PC4 x 2	62/32 PC4 x 62/32 GPC4
500 L/C	1996-00	6206 PC4	6206 PC4 x 2	62/32 PC4 x 62/32 GPC4
500 LC	2000-10	5206 S9	6206 PC4 x 2	62/32 PC4 x 62/32 GPC4
440 LC PRO X	1998-03	6207 PC4	DG3572201C4	DG3572201C4 x 6207PC4
440 LC PRO X	2004-07	6207 PC4	DG3572201C4	DG3572201C4 x 6207PC4
500-600 L/C USA	1998-03	6207 PC4	DG3572201C4	6207/9BA9T x 6207 PC4
500-600 L/C PRO X	2004-09	6207 PC4	DG3572201C4	6207/9BA9T x 6207 PC4
600-700 L/C	1997-98	6207 PC4 x 2	6207 PC4 x 2	6207 GPC4 x 6207 PC4
600 HO	2007-09	DG3572201C4	DG3572201C4	6207/9BA9T x 2
600 IQ	2008	DG3572201C4	DG3572201C4	6207/9BA9T x DG3572201C4
700 LC Dragon-RMK	2008-10	DG3572201C4	DG3572201C4	6207/9BA9T X 2
600-700 L/C	1999-05	6207 PC4 x 2	6207 GPC4 x 2	6207/9BA9T x 6207 PC4
600-700 L/C HD pto	1999-05	6207 PC4 x 2	6207 GPC4 x 2	5207 S9C4 x 6207 PC4
700 L/C Classic	2006-10	6207 PC4 DG3572201C4	6207 GPC4 x 2	5208C4 x 2
700 L/C Frontier 4-t	2002-04			6207/9BA9T x 6207 GPC4
800 L/C USA	2000-05	6207 PC4 x 2	6207 GPC4 x 2	6207/9BA9T x 6207 PC4
800 L/C Heavy duty	2000-05	6207 PC4 x 2	6207 GPC4 x 2	5207 S9C4 x 6207 PC4
900 L/C	2005-06	6207 PC4 x 2	6207 GPC4 x 2	5208C4 x 2
3- CYL L/C				
580 L/C mono block	1992-94	6206 PC4	6206 PC4 x 4	6206 GPC4 x 6206 PC4
600 L/C mono block	1995-97	5206 S9	6206 PC4 x 4	6206 GPC4 x 6206 PC4
600 L/C oil jet	1997-00	5206 S9	6206 PC4 x 4	6206 GPC4 x 5206S9
600 SP-680 L/C	1996	35BG06 S9	6007 PC4 x 4	6207 GPC4 x 6207 PC4
650 L/C CARB-RXL	1985-98	5206-S9	6206 PC4 x 2	6206 GPC4 x 5206S9
600-680-700 XRC	1997-98	35BG06 S9	6007 PC4 x 4	6207 PC4 x 6207 GPC4
750-800 L/C Storm	1993-98	6207 PC4 x 2	6207 PC4 x 4	6307 GPC4 x 6307 PC4
700-800 XCR	1999-03	35BG06 S9	6007 PC4 x 4	6207 GPC4 x 6207 PC4

Part number 35-	Dimensions		Parts number 35-	Dimensions
6206 C4	30 X 62 X 16		5206 S9	30 X 62 X 23,8
6206 PC4	30 X 62 X 16		5207 S9C4	35 X 72 X 27
6206 GPC4	30 X 62 X 16		5208 C4	40 X 80 X 30,2
6207 PC4	35 X 72 X 17		62/32 GPC4	32 X 65 X 17
6207 GPC4	35 X 72 X 17		35BG06 S9	35 X 62 X 23,8
6207/9BA9T	35 X 72 X 24		DG3572201C4	35 X 78 X 20
6307 PC4	35 X 80 X 21	48	6307 GPC4	35 X 80 X 21

Kurbelwellen-Lagerfett

35-900 Lagerfett 300 g Verwenden, wenn die PTO und /
35-901 Lagerfett 50 g oder MGT Kugellager ist ein
 Beumschlossenen Raum.



Nadellager

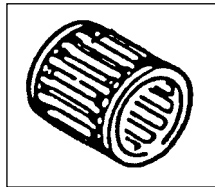

35-500	19 x 23 x 24 (1414)	35-513	16 x 20 x 20
35-501	16 x 20 x 22 (1404)	35-514	15 x 19 x 20
35-502	16 x 21 x 20 (1407)	35-515	16 x 22 x 17
35-503	18 x 23 x 22 (1413)	35-517	20 x 24 x 30
35-505	18 x 22 x 22 (1410)	35-520	18 x 23 x 21
35-506	16 x 20 x 24 (1406)	35-521	20 x 25 x 24
35-508	20 x 24 x 19 (1415)	35-522	16 x 20 x 22,5
		35-523	20 x 26 x 24
35-510	18 x 22 x 28 (1411)	35-524	20 x 20 x 22,7
35-512	20 x 24 x 24 (1412)		

Simmerringe

Arctic Cat

09-14600	30x62x10
09-14603	30x65x9/11
09-14605	35x75x9/11
09-14613	25x55x9
09-14616	35x75x8/10
09-14617	35x55x7

Ski-doo

09-113	30x42x7
09-11301	32x42x7
09-116	25x62x10
09-118	25x41,55x10
09-122	35x62x10
09-125	25x52x7/7,5
09-16002	25x62x63,5x5x6
09-16003	30x62x63,5x5x6
09-165	35x72x7/8
09-167	30x62x7/8
09-168	28x38x7
09-169	30x47x7
09-170	40x80x7

Sachs

09-108	30x47x8
09-114	25x35x7,9

Polaris

09-140	30x62x8
09-14102	30x44x7
09-14103	30x62x8/11
09-14104	30x44x5,7
09-14202	30x62/63,7x7
09-14619	40x64x8

Kohler

09-104	25x42x10/11
09-113	30x42x7

Yamaha

09-131	25x48x8
09-132	30x72x8
09-135	32x78x10x13
09-137	32x78x9,5
09-143	32x48x10
09-14301	35x80x6
09-14302	25/32x78x8
09-14303	25/32x48x8
09-14306	23/35x58x12
09-14311	32x48x9,2
09-14313	32x48x10

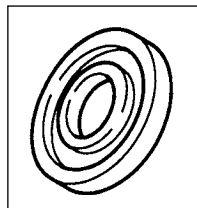

Arctic Cat



07-100 01
JAG 87-91, 0109-926

Polaris:



07-100 05
VM 38 SS, 3083171

Rotax



07-100 10
VM 34 straight

Vergaser Adapter



VM 30, 32, 34 HD
07-100 13



07-100 06
VM 32, 34, HR, 3083306



07-100 11
VM 34, 570.1262.00



07-100 20
TUNDRA VM 34



07-100 23
VM 40, 44, 570.038.200

Yamaha



07-100 13
VM 30, 32, 34 HD



07-100 13
VM 30, 32, 34 HD



07-100 12
VM 570.1261.00



07-10021 MX 85-92

Vergaser Adapter
Eignung für angezeigt

www.teolehtimaki.fi

und es öffnen Sie die
richtigen Seite.
Gleichzeitig finden Sie
andere Ersatzteile



07-100 22
VM34,79-84, 570.1339.00

Wössner Hi-Performance Forged Pistons

Model	piston number	cyl	displ. cc	bore	over sizes	Kimpex number
Arctic Cat						
Z440 1995-98, Jag 440	09-7001	2	431	65.00	std	09-696
Bearcat 440 1993-00						
ZL/ZR 500, Powder Spec -00	09-7004	2	497	71,00	std	
Bearcat 550 1995-02	09-7005	2	550	73,40	std	09-683
ZL 550, ESR 2001-2003						
EXT Triple 600 1996-97	09-7006	3	594	66,50	std	09-601
ZRT 600 1996-00						
ZL/ZR 600, EFI 1998-99	09-7007	2	599	78,00	std	
Powder Special 1998-00						
Mountain CAAt 2001-04	09-7008	2	599	78,00	std	09-609
Pantera EFI 2002-05						
ZL/ZR 600, R 600, 2000-03						
Crossfire 7 -06, F7 2003-06	09-7009	2	698	79,70	std	09-657
MCat 700, WildC 91-00	09-7010	2	699	81,00	std	09-682
ZR 700, ZL 700 1994-00						
MCat, ZL, ZR 800, 2001-04	09-7011	2	785	81,00	std	09-611
ZRT 800, Pantera 1995-01	09-7012	3	794	72,00	std	09-602
Thunder Cat 1000, 1998-02	09-7013	3	1000	81,00	std	09-612
Polaris						
Fuji Motor	09-7015	2	544	73,00	std	09-727
550 Classic 2003-04						
Indy 550 models 1999-2009						
Liberty Motor	09-7016	2	593	74,50	std	09-721
600 RMK 1998-01,						
Indy 600 CX, SP 1998-01						
Liberty Motor	09-7017	2	600	77,24	std	09-728
600 Classic, Edge Tour 00-06						
600 IQ, RMK, ProX, 02-09						
Indy 600 XCSP Ves 00-05						
Liberty Motor	09-7018	2	700	81,00	std	09-722
700 Class, ProX, RMK, 97-07						
XC700, SP, Switchb. 1998-05						
Liberty Motor	09-7019	2	784	85,00	std	09-730
800 Clas. Edge, ProX 03-05						
800 RMK, SKS, XCSP, 01-05						
Liberty Motor	09-7020	2	866	83,00	std	
900 Fusion, RMK, Sw. 05-06						

Wössner Hi-Performance Forged Pistons

Model	piston number	cyl	displ. cc	bore	over sizes	Kimpex number
Rotax = Skidoo, Lynx						
593 H.O Engine Type	09-7021	2	594	72,00	std	09-776
Exp. TUV 2005-10, GSX, GTX						
GT 600 Sport 2003, Legend						
Legend 600 Sdi, SE600 2004						
MXZ Blizz, Adr, 2003-09						
Renegade 600, X, 2003-09						
MXZ Rev, Trail, X, 2003-05						
Scandic 600 SUV 2008						
Rotax 593/600 E-Tec						
793 Engine Type	09-7022	2	800	82,00	std	09-778
GT 800 Se, Legend 2003,						
All PTEK models 2007						
GTX, GTX Ltd, 2005-06						
MXZ 800, Rev, 200-03						
MXZ 800 Adr, X, 2005-06						
Summit 800, HM, HO, 00-06						
800R Engine type	09-7023	2	800	82,00	std	
GSX Ltd 800R 2008						
MXZ 800R all, 2008-09						
Renegade 800R, all 2008-09						
Summit 800R all, 2008-09						
494 Engine type	09-7028	2	494	69,50	std	09-780
Formula 500 LC 2000						
Formula DL, Z 500, 1998-00						
GT 500, 1998-01						
MXZ 500, Trail, 1998-01						
Skandic 500 1997-00						
Touring 500 LC, 2000						
Yamaha						
SX 500R, 00-01, VT 1999-01	09-7024	2	493	68,00	std	09-829
V-max 500 1994-01						
Mountain Max 600, 1998-99	09-7025	2	598	74,80	std	09-826
V-Max 600, 1994-99, VT -98						
SX 700R 2000-01	09-7026	3	698	70,50	std	
Venture 1998-03						
V-Max, MMax 1997-04						
SRX 700 1998-02	09-7027	3	696	69,00	std	09-831
Mountain Max 700 1998						

Engine gaskets, professional

Number	Arctic Cat year gasket 840-old p/n	Piston
710-060A	FS CAT 440 FC, 80- , 09-696, 840-80607	09-696
710-063	FS CAT 500 CC, FC, 78-85, 09-693	09-693
710-063B	FC CAT 340 FC, 77- , 09-692, 840-80588	09-692
710-063C	FS CAT 500 EL T. 6000, 80-85, 09-694	09-694
710-063D	FS CAT 530 LC, 86-91, 09-699, 840-80632	09-699
710-063E	FS CAT 500 FC, 86-90, 09-691, 840-8061	09-691
710-179	FS CAT 440 LC 90-00, 09-695, 840-8181	09-695
710-180	FS CAT 700 LC, 91-96, 09-682, 840-8180	09-682
710-189	FS CAT 550+580 91- , 09-681+683+687, -8182	09-681-683
710-193	FS CAT 800 3-CYL. 95-01, 09-602	09-602
710-216	FS CAT 594, 3-CYL. 95-02, 09-601	09-601
710-227	FS CAT ZR500, - 98, 09-605	09-605
710-262	FS CAT 800 2-CYL. 01- , 09-611	09-611
710-266	FS CAT ZL600, 01-02, 09-609	09-609
710-267	FS CAT ZR700, 99-00,	09-
710-270	FS CAT ZL 570	09-
	Rotax Ski-Doo Lynx Trapper Nordik	
710-022X	FS ROTAX 640 74- , 09-762-763	09-762-763
710-023A	FS ROTAX 377, -89, 09-751	09-751
710-023C	FS ROTAX 377, 90-95, 09-751, 841-80238	09-751
710-024	FS ROTAX 250, 71-96, 09-740, ELAN, 8024	09-740
710-025	FS ROTAX 440 (467) 71- , 09-761	09-761
710-026	FS ROTAX 340 76- , 09-747-748	09-747-748
710-119	FS ROTAX 250 TWIN, 73- , 09-745	09-745
710-162A	FS ROTAX 503 -95, 09-741, 841-8162	09-741
710-162B	FS ROTAX 503 -90, 09-741 , 841-8162	09-741
710-162C	FS ROTAX 447 -95, 09-752, 840-8124	09-752
710-163A	FS ROTAX 454 BLIZZ, 79- , 09-760	09-760
710-164	FS ROTAX 253, 85-93, 09-741, 841-8123	09-741
710-165	FS ROTAX 521, 09-741	09-741
710-165C	FS ROTAX 467, -95, 09-761	09-761
710-177	FS ROTAX 536 , 89- , 09-741	09-741
710-178C	FS ROTAX 583 -95, 09-772	09-772
710-194	FS ROTAX 582, -95 , 09-772	09-772
710-195	FS ROTAX 277, 1996- 09-741	09-741
710-196	FS ROTAX 503 FC 95- , 09-741, O-RENGAS	09-741
710-197	FS ROTAX 670, 93-95, 09-773	09-773
710-203	FS ROTAX 467 , 94-96, 09-761	09-761
710-210	FS ROTAX 380, 440, 1996- , 09-751, 09-752, O-	09-751-752
710-211	FS ROTAX 454, 95-97, 09-760	09-760
710-212	FS ROTAX 494 LC, 96-01, 09-780	09-780
710-213	FS ROTAX 599, 3-CYL. 09-774	09-774
710-214	FS ROTAX 599, 3-CYL. 09-774	09-774
710-215	FS ROTAX 670, 95- , 09-773	09-773
710-221	FS ROTAX 800 97-01, 09-782	09-782
710-222	FS ROTAX 700, 97-00, 09-781	09-781
710-235	FS ROTAX 600 , 99- , 09-785	09-785

Engine gaskets, professional

Number	Rotax Ski-Doo Lynx Trapper Nordik	Piston
710-255	FS ROTAX 700, 00-02, 09-783	09-783
710-256	FS ROTAX 493, 00-05, 09-784	09-784
710-259	FS ROTAX 593 RAVE, 09-785	09-785
710-261	FS ROTAX 800 , 02-03	
710-277	FS, ROTAX 552, 03---, 09-779	09-779
710-278	FS ROTAX 594 HO 03-05, 09-776	09-776
	Polaris	
710-069	FS POL 244, ALL, 09-700, 840-8069	09-700
710-070	FS POL 250 74-78, 09-702	09-702
710-071	FS POL 250, 76-89, 09-703	09-703
710-073	FS POL 340 77-81, 09-708	09-708
710-075	FS POL 340 73-82, 09-706	09-706
710-078	FS POL 440 75-81, 09-704	09-704
710-079	FS POL 440 75-80, 09-705	09-705
710-109C	FS POL 400 2-CYL. 84-91, 09-707	09-707
710-110	FS POL 600 3-CYL. 84-87, 09-707	09-707
710-110A	FS POL 440 82-99, 09-710	09-710
710-110C	FS POL 488 FC 86-99, 09-712, 840-81108	09-712
710-173	FS POL 340, 86-93, 09-709 JA 94-, 09-717	09-709
710-181A	FS POL 650 88-97, 09-713, 840-8187	09-713
710-185A	FS POL 488 LC, 89-02, 09-711, 840-8188	09-711
710-186	FS POL 440 FC 91-99, 09-710	09-710
710-191	FS POL 580 93-94 , 09-714	09-714
710-204	FS POL. 94-97, 09-716	09-716
710-205	FS POL 600 3-CYL. 95-00, 09-716	09-716
710-206	FS POL 679 3-CYL. 96-97 , 09-718	09-718
710-231	FS POL. XC700, 98-01, 09-721	09-721
710-238	FS POL FC 550, 99- , 09-727	09-727
	Yamaha	
710-027A	FS YAMAHA 250 BRAVO 84- , 09-800	09-800
710-140A	FS YAMAHA 535, 83-91, 09-816	09-816
710-142	FS YAMAHA EX 340 81-88, 09-802	09-802
710-142C	FS YAMAHA 340 , 89- , 09-802	09-802
710-146	FS YAMAHA EX 440 76-81, 09-806	09-806
710-147C	FS YAMAHA SS440 80-83, 09-807	09-807
710-167	FS YAMAHA 535 CC SRV 82-90, 09-808	09-808
710-167A	FS YAMAHA 540,540 SRV 85-90	09-808
710-168	FS YAMAHA PZ 480 84-90, 09-813	09-813
710-168B	FS YAMAHA 485 CC, -07, 09-813	09-813
710-171	FS YAMAHA 570 -90, 09-817	09-817
710-171A	FS YAMAHA 570 CC, 91-, 09-817	09-817
710-182	FS YAMAHA 535 VIKING 92- 07, 09-808	09-808
710-200	FS YAMAHA 494 CC 94-96, 09-825	09-825
710-201	FS YAMAHA 598 CC 94-95, 09-826	09-826
710-239	FS YAMAHA 485 CC, (500) -07 09-813	09-813

Arctic Cat Kolben Gaskets Needle cage Oil seals

Arctic Cat	dia mm	ccm/cm3	gasket	needle cage	oil seal magn	oil seal
EXT 600 Tr. 97-98 EXT 600 Triple Touring 1998 Powder EXT 600 1997-98 ZRT 600 1995-98						
09-601	66,50	594 3-syl	710-216	35-503	09-14618	09-14619
Pantera 800 1998-01 ZRT 800 1995-01						
09-602	72,00	794 3-syl	710-217	35-523	09-14618	09-14619
ZL 500 EFI 1998-01; ZR 500, ERSI 1998-01; Powder SP 500 EFI 1999-01						
09-679	71,00	497 2-syl		35-523	09-14618	09-14619
EXT 580 MC; EXT 580 EFI MC 1993-97; 580 Powder SP 1995-97; ZR 580 1993-97; Pantera 580 1995-97						
09-681	75,40	580 2-syl	710-189	35-523	09-14618	09-14619
Wildcat 700 MC. EFI 1991-96, ZR 700 1995, ZL 700 2000, ZR 700 1999-00						
09-682	81,00	699 2-syl	710-190	35-523	09-14617	09-14619
EXT special 1991-92; EXT Mountain Cat 1991-92; EXT 550 EFI, EFI Mtn Cat 1993-94 Bear Cat 550WT 2000-						
Pantera 550 2002-05, Panther 550 2000-01, ZL 550 ESR 2000-03						
09-683 (687)	73,40	550 2-syl	710-189	35-523	09-14618	09-14619
Wildcat 650 1988-90, Mountain Cat 1990						
09-684	78,00	650 2-syl		35-523		
Panther, Puma, Cheetah, Pantera 1971-1975 Lynx II -74Jag 340 -75						
09-685	60,00	339 2-syl		35-525		
Bearcat 550 1995-98; Cheetah 550 1994; Cougar 550 1995-98; EXT 550, EFI 1993-98;						
Pantera 550 1993-94; Panther 550 1997-98; Prowler 550 1995						
09-687	73,40	550 2-syl	710-189	35-523	09-14618	09-14619
El Tigre 440 Z 1975-77; Kawasaki Intriguer, Intruder, Invader; Drifter 440 1978-81						
09-689	68,00	440 2-syl		35-522	09-14603	09-14603
Cheetah FC, Cougar 1986-90						
09-691	70,00	500 2-syl	710-063E	35-503	09-14603	09-14603
Bearcat 340 1995-01; Cheetah 340 1994; Jag 340 1976-77, 1987-90; Jag 3000 FA, FC 1978-80						
Jag Deluxe 1987-90; Jag Mountain Cat 1990-91; Jag 340 DeLuxe 1998-99; Panther 340 1998-01						
Trail Cat 3000 FC 1980; Manx, Manx Deluxe 1991-93; Manx Mountain Cat 1992-93; Puma DeLuxe 1994-97						
09-692	60,00	339 2-syl	710-063B	35-502	09-14603	09-14603
Cheetah 5000 1976-78; El Tigre 500 1976; El Tigre 5000 1977-81; Pantera 5000 1976-81; Panther 500						
1976Cougar Spec. Edition 1985; Panther 1986-88; Pantera el. 1980; Manx 2000S 1977-80, El Tigre 6000 LC 1980-85						
09-693	70,00	500 2-syl	710-063	35-503	09-14603	09-14603
El Tigre 6000 LC 1980-85						
09-694	70,00	500 2-syl	710-063C	35-503	09-14603	09-14603
El Tigre 6000 LC 1978-79; El Tigre Cross Country 1979; Pantera LC 1985-92; El Tigre 5000 LC 1987Jag 440 LC						
1987; Panther 440 LC 1996; ZL 440 1997-99; Prowler 1990-94; Cheetah Touring 1991-93; Cougar 1991-94.						
09-695	68,00	440 2-syl	710-063A	35-503	09-14603	09-14603
Bearcat 440 1995-01; Cheetah 440 1994; Panther 4000 FC 1980-81; Trail Cat 4000 FC 1980-81;						
Jag 4000 FC 1980-81; Jag AFS LT 1991-93; Jag FC 1985-87; Jag 440 DeLuxe 1988-99						
Jag 440 Z 1991-96; Panther DeLuxe 440 1984-01; Z 440 ES 1990-01; Super Jag 1991-92						
09-696	65,00	431 2-syl	710-060A	35-502	09-14603	09-14613
Cheetah LC 1986-89; El Tigre 6000 1986-89; El Tigre EXT 1989-91; El Tigre Ext Mountain Cat 1990						
09-699	72,00	529 2-syl	710-063D	35-503	09-14603	09-14605

Piston rings

MOS 2 surface

Gudgeon pin

Rotax 503-253

10-741-00
10-741-01
10-741-02
10-741-04

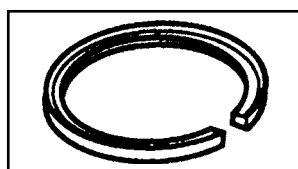

Rotax 377

10-751-00
10-751-01
10-751-02
10-751-04

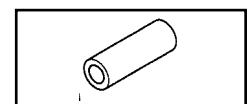

11-741
11-751

Skidoo, Rotax

Kolben Gaskets Needle cage Oil seals

Ski-Doo	dia mm	ccm/cm3	gasket	needle cage	oil seal magn	oil seal
Spirit 250 1976-78; Elan 250 E 1971-78						
09-740	69,00	247 1-syl		35-505	09-118	09-118
09-740-02	69,50					
09-740-04	70,00					
Spirit 250 1979-83; Elan 250 1979-96						
09-740-02	69,50	250 1-syl		35-505	09-118	09-118
09-740-04	70,00					
Rotax 253, 277, 503,521,536 Lynx, Nordik, Ockelbo, Skidoo, Trapper, Winha, Freestyle, Tundra						
09-741	72,00	253 1-syl	Katso	35-505	09-126	09-146
09-741-01	72,25	277 1-syl	tiiviste	35-505	09-168	09-169
09-741-02	72,50	503 2-syl	kelkka-	35-505	09-165	09-167
09-741-04	73,00	521 2-syl	kohtaisesta	35-505	09-167	09-165
09-741-06	73,50	536 2-syl	luettelosta	35-505	09-167	09-165
Olympic 320, 320E 1969; Olympic 300, S, M, 1971-77						
09-742	76,00	319 1-syl		35-505	09-118	09-118
09-742-02	76,50					
Elan 250 1973-79						
09-745	54,00	247 2-syl	710-119	35-514	09-118	09-118
09-745-02	54,50					
Olympic 335 1969-72; Skandic 1970-73						
09-746	78,00	335 1-syl		35-505	09-118	09-118
09-746-02	78,50					
TNT 340, 1972-76; Olympic 340, E 1975-79; Everest 340, E 1977-79; Futura 340 1975; Nuvik 340, E 76-79						
09-747	59,50 left	339 2-syl		35-505	09-167	09-167
09-747-02	60,00 left					
09-747-04	60,50 vasen					
09-748	59,50 right	339 2-syl		35-505		
09-748-02	60,00 right					
09-748-04	60,50 oikea					
Blizzard 6500 Plus, 7500 Plus, Cross Country 1978-81; Super Sonic 1979-81						
09-750	59,50	339 2-syl		35-505	09-165	09-167
09-750-02	60,00					
Rotax 377 ; Lynx, Nordik, Ockelbo, Skidoo, Trapper, Winha						
09-751	62,00	377 2-syl	Katso	35-505	09-165	09-167
09-751-01	62,25		tiiviste			
09-751-02	62,50		kelkka-			
09-751-04	63,00		kohtaisesta			
09-751-06	63,50		kohtaisesta			
Rotax 447; Lynx, Ockelbo, Skidoo, Trapper, Scandic 440 LT 2001-07, MXZ 440 1999-01, TOUR. E 1999-						
09-752	67,50	447 2-syl	710-162C	35-505	09-165	09-167
09-752-01	67,75					
09-752-02	68,00					
09-752-04	68,25					
Everest 440 FC 1974-79; TNT 440 FC 1975-78; Olympic 1977; Futura 440 1975-79; Nuvik 440 1977						
09-758	67,5 left	436,6 2-syl		35-505	09-122	09-116
09-758-02	68,00					
09-759	67,5 right	436,6 2-syl		35-505	09-167	09-167
09-759-02	68,00					

Ski-Doo	dia mm	ccm/cm3	gasket	needle cage	oil seal magn	oil seal
Blizzard 9500 1979-82; Ultra Sonic 1980-82						
09-760	67,50	436,6 2-syl	710-163A	35-505	09-167	09-167
09-760-01	67,75					
09-760-02	68,00					
09-760-04	68,50					
Rotax 444, 467; Elite 450 LC 1978-79; Everest 444 LC 1978-79; Everest 464 LC 1980-83; SS-25 1984 Grand Tour. 470 1995; Formula SS 1985; Formula St 1994; Formula SP 1985-86; Formula MX, LT, XTC 1985-95 Formula MXZ 1993-94; Safari GLX, LC, LCE 1990-92; Summit 470 1994-95						
09-761	69,50	436,6 2-syl	710-025, -71-	35-505	09-167	09-167
09-761-01	69,75					
09-761-02	70,00	462,8 2-syl	710-165C, -95	35-505	09-167	09-165
09-761-04	70,50		MOS 2 surface			
Alpine 640 1969-82; Nordic 640 1970-74; TNT 640 1971-72; Valmont 1971-72						
09-762	76,00 left	635 2-syl		35-505	09-103	09-103
09-762-02	76,50					
09-762-04	77,00					
09-763	76,00 right	635 2-syl		35-505		
09-763-02	76,50					
09-763-04	77,00					
Rotax 583, 621; F Mach 1, XTC 1989-92; F Plus, E, XTC, X 1992-93; F Plus EFI 1993-94; F GT 580 1993-96; F STX 1994-96; Summit 1994-96; F Z 1994-96						
09-772	76,00	583 2-syl	710-178C, 583	35-505	09-167	09-165
09-772-01	76,25					
09-772-02	76,50	617 2-syl	710-194, 582			
09-772-03	76,75					
09-772-04	77,00					
Rotax 670; Mach 1 X 1993; Mach 1 1993-96; MXZ 670 1996-99; GT SE 1994-96; F SS 670 1995-96; Summit 670						
09-773	78,00	669 2-syl	710-215	35-524	09-167	09-165
09-773-01	78,25					
09-773-02	78,50					
09-773-04	79,00		MOS 2 pinnoite			
Formula 3 600 1995-97						
09-774	64,50	600 3-syl		35-503		09-165
Rotax 550 fan 2003-						
09-779	75,86	550 2-syl	710-277	kehä	09-165	09-165
09-779-01	76,11					
09-779-02	76,36					
09-779-04	76,86					
Rotax 500, 780; F Z 500 1999; F 500, DLX, SLS 1996-00; GT 500 1996-99; Mach Z 780 1993-97; MXZ 500 98-Scandic WT LC 1999-00; Summit 500 1996-99; Touring 500 LC 2000						
09-780	69,50	500 2-syl	710-212	35-505		09-165
09-780-02	70,00	779 3-syl				
Rotax 700; F 3 700 1998-00; GT 700 1998-00; GT SE 1997-98; Mach 1 700 1997-00						
09-781	69,80	699 3-syl	710-222	35-503		09-170
Mach Z 800 1997-99; F 3 800 1999, Mach Z 800 1997-2002,						
09-782	70,50	796 3-syl	710-221	35-503	09-170	09-170
Formula 700, Legend 700, MXZ 700 Summit 700 2000-2002						
09-783	78,00	700 2-syl	710-255			

Skidoo, Rotax

Kolben Gaskets Needle cage Oil seals

Formula600 1999-01, Formula 600 GS 2001, Formula Z 1999-00, GT 600 1999-01, MXZ 600 1999-02

Scandik 600 WT L/C 2001-02, Summit 600 1999-01, GT 600 GS, SE, Sport, Legend 600 2002

MXZ 600 Adr., Renegade, Sport, Trail, RER Sport, Sport 2002, Lynx 600 L/C models

09-785	76,00	597 2-syl	710-259			
09-785-02	76,50					

Polaris Pistons Gaskets Needle cage Oil seals

Polaris	dia mm	ccm/cm3	gasket	needle cage	oil seal magn	oil seal.
Charger, Mustang 488 1971; Voyager 488 1971; Colt 250 1972-78; Custom 2 1971; TC 250 1974-75;						
Electra 250 1975-77; Gemini 244 1979-83; Star 1983-90; Startrak 1987-90; Starlite Gt 1991-95						
09-700	72,00	488 2-syl	710-069	35-520	09-14102	09-14102
09-700-02	72,50	244 1-syl				
09-700-04	73,00					
Colt 250 1976-78						
09-702	53,50	250 1-syl	710-070	35-520	09-14103	09-14102
Starfire 250 1976; TX 250 1976-79						
09-703	53,40	250 1-syl		35-520	09-14103	09-14102
TX 440 1973; Electra 440 1974-77; Cobra 440 1978-79; Galaxy 440 1980-81; Cutlass 440, E 1981-82;						
TX-C 440C 1981; Long Track 1983-86; Sport, Super Sport SS 1983						
09-704	67,72	432 2-syl	710-078	35-520		
09-704-02	68,22				09-14102	09-14102
TX 440 1976-80						
09-705	67,75	440 2-syl	710-079	35-520	09-140	09-140
Starfire 340. 1976, TX 340 F/A 1973-82						
09-706-01	62,00	336 2-syl	710-075	35-513		
Indy 400 1984-1991; Indy 600 1984-87						
09-707	65,00	398 2-syl	710-109C	35-503	09-14102	09-14102
09-707-01	65,25					
09-707-02	65,50	597 3-syl	710-110			
09-707-04	66,00					
Colt SS 340 1977; Cobra 340 1978-79; SS 340 1979; Apollo, Galaxy, Cutlass 340 1979-1981						
09-708	61,78	333 2-syl	710-073	35-513	09-14102	09-14102
09-708-02	62,28					
Sprint ES 1986-90; Indy Sport, GT 1987-90; Indy Lite, GT, Starlite 1991-93						
09-709	62,25	339 2-syl	710-173	35-525	09-14102	09-14102
09-709-01	62,50					
09-709-02	62,75					
09-709-04	63,25					
TXC 440 FC 1982; Indy Trail 1983-1986; Long Track 1984-90; Indy Sport 1991-98; Sport GT 1991-93						
Sport Touring 1995-98; Super Sport 1995-96; Transport 1996-98						
09-710	67,75	440 2-syl	710-186	35-503	09-14102	09-14102
09-710-02	68,25					
09-710-04	68,75					
Indy 500 LC, Classic 1989-00; Indy 500, SKS, SP, 1990-98; Indy 500 EFI 1992-98						
Indy Classic Touring 1993-94; Indy Widetrack 1997-98						
09-711	72,00	488 2-syl	710-185A	35-503	09-14102	09-14102
09-711-01	72,25					
09-711-02	72,50					
09-711-04	73,00		MOS 2 surface			
09-711-06	73,50		58			

Polaris

Kolben Gaskets Needle cage Oil seals

Polaris	dia mm	ccm/cm3	tiivistesarja	neulalaakeri	tiiviste .magn	tiiv.kytkin
Indy Trail FC 1986; Indy Tr. DeLuxe 1988-92; Super Sport 1997-98; Supertrac 1991-93; Indy Trail, Touring 1994-99						
09-712	72,00	488 2-syl	710-110C	35-503	09-14202	09-14202
09-712-01	72,25					
09-712-02	72,50					
09-712-04	73,00					
Indy 650, SKS 1988-93; Indy 650, RXL, SKS, 1990-97						
09-713	67,75	648 3-syl	710-181A	35-503	09-14202	09-14104
09-713-01	68,00					
09-713-02	68,25					
09-713-04	68,75					
Indy 580 XLT, SKS, XLT SP 1993-94						
09-714	64,00	579 3-syl	710-191	35-525	09-14202	09-14202
09-714-01	64,25					
09-714-02	64,50					
09-714-04	65,00					
Indy 440 XC 1992; Indy 440 XCR 1993-94; Indy Trail DeLuxe 1993						
09-715	67,72	440 2-syl		35-503	09-14202	09-14202
09-715-01	67,97					
09-715-02	68,22					
Indy XLT 600 1995-98; XLT SP 1997-98; Indy XCR 600 1995-97; XC 600 1997						
09-716	65,00	597 3-syl	710-205, 95-00	35-525	09-14202	09-14202
09-716-01	65,25					
09-716-02	65,50		710-204, 94-97			
Indy Lite, DeLuxe; Indy Lite Gt 1994-98; Indy Lite Touring 1998						
09-717	62,30	340 2-syl		35-525	09-14202	09-14202
09-717-01	62,55		MOS 2 pinnoite			
09-717-02	62,80					
09-717-04	65,50					
Indy Ultra SP, Ultra SPX, SE, Ultra Touring 1996-97						
09-718	66,50	679 3-syl	710-206	35-503		
Indy Storm 800 1994-98						
09-719	72,00	794 3-syl		35-503		
RMK 500, SKS 2000-02, 500 XC1999-02, Indy500 99, Indy 500 XC SP 1999-07, Indy 500 2001						
09-720	70,50	500 2-syl				
09-720-02	71,00					
Indy 550 Classic, Sport Touring, Supersport 1999-2006, Pro X Fan,						
09-727	73,0	550 2-syl	710-238	35-503		
09-727-01	73,25					
09-727-02	73.50					
09-727-04	74,00					
Indy 600 Classic, Touring 2001, Indy 600 Touring 2000, 600 XC SP, Edge 2000, 600 XC SP 2001						
09-728	77,25	600 2-syl				
Indy 800 XC SP 2001-05, 800 SKS 2003, 800 Classic 2004, 800 LE 2001, 800 Pro X 2003-04, 800 Edge 04						
09-730	85,00	800 2-syl		35-526		

Yamaha Kolben Gaskets Needle cage Oil seals

YAMAHA	dia mm	ccm/cm3	gasket	needle cage	oil seal magn	oil seal
Br 250 1982-94 Br 250T, TS 1985-00; BR 250 TS 1984-97						
09-800	70,00	246 1-syl	710-027	35-505	09-131	09-132
09-800-01	70,25					
09-800-02	70,50					
ET 250 1977-81						
09-801	72,96	246 1-syl	710-138	35-522	09-131	09-132
09-801-01	73,21					
09-801-02	73,46					
09-801-04	73,96					
EC 340 1982-88 ET 340 1978-88 CS 340 1989-00						
09-802	60,00	337 2-syl	710-142	35-522	09-131	09-132
09-802-01	60,25					
09-802-02	60,50					
09-802-04	61,00					
GP 338 1973 SL 338 1974 GS 338, 340 1976-1979						
09-803	60,00	338 2-syl		35-505	09-135	09-143
09-803-02	60,50					
09-803-04	61,00					
EX 340 1976-78 STX 340 1976-1977						
09-804	60,00	338 2-syl	710-141	35-505	09-137	09-143
09-804-02	60,50					
GP; TL, 433 1975 EX 440 1976-81 GP 440 1976-78 PR 440 1976-77 STX 1976-77						
09-806	68,00	433 2-syl	Katso tiiviste	35-505	09-137	09-143
09-806-01	68,25		kelkkakohtaisesta			
09-806-02	68,75		luettelosta			
09-806-04	69,00					
SS 440 1980-83						
09-807	66,00	440 2-syl	710-147C	35-505	09-137	09-143
09-807-02	66,50					
EC 440 1979-84 SR 540 1980-91 XL 540 1985-90 VK 540 1988-00						
09-808	73,00	535 2-syl				
09-808-01	73,25					
09-808-02	73,50					
09-808-04	74,00					
SL 292 1971-72						
09-810-02	73,50	292 1-syl		35-505		
ET 300 1980-84						
09-811	56,00	294 2-syl	710-138A	09-505	09-135	09-143
09-811-02	56,50					
GP 292 1972-73 SM 292 1973-74						
09-812	73,00	292 1-syl		35-505		
09-812-02	73,50					

Siehe die Dichtung www.teolehtimaki.fi Liste. Dies ist der Fall des Kolbens immer der Fall ist seit vielen Jahren, und die Dichtung kann bis zu einem gewissen Modell zu ändern. Darüber hinaus beachten Sie bitte, alle die Schlitten nicht unbedingt auf dieser Seite aufgelistet.

Yamaha Kolben Gaskets Needle cage Oil seals

YAMAHA	dia mm	ccm/cm3	gasket	needle cage	oil seal magn	oil seal
PZ 480 1984-98 480 ST 1991-98 VT 480 1991-97 VT 480 GT 1993-9 VT 480 TF/X 1993-00						
PZ 500 1999-00; PZ 500 ML 2000 PZ Mtn 480 1999 Venture 500 1999-06						
09-813	72,00	485 2-syl	710-168	35-505	09-14303	09-14302
09-813-01	72,25		Katso tiiviste			
09-813-02	72,50		kelkkakohtaisesta			
09-813-04	73,00		luettelosta			
SR 433, GPX 433 1971-75						
09-814	68,00	433 2-syl		35-505	09-137	09-143
09-814-01	68,25					
09-814-02	68,50					
09-814-04	69,00	433 2-syl		35-505		
GPX 338 F/A 1974-75						
09-815	60,00	338 2-syl		35-505	09-137	09-143
09-815-01	60,25					
09-815-02	60,50					
VMX 540 1983-91						
09-816	73,00	535 2-syl	710-140A	35-521		
Exciter 570, 1987-90 Exciter 2, 1991-92						
09-817	73,00	569 2-syl	710-171	35-521	09-14313	09-14301
09-817-02	73,50		710-171A			
09-817-04	74,00		MOS 2 surface			
SRX 440 1978-1980						
09-818	68,50	439 2-syl	710-147A	35-512	09-137	09-143
09-818-01	68,75					
09-818-02	69,00					
V-Max 500 LE, DX, ST, 1994-96						
09-825	68,00	493 2-syl	710-200	35-521		
V-Max 600, LE, DX, ST, 1994-96						
09-826	74,80	598 2-syl	710-201	35-521		
09-826-02	75,30					

Kohler, Sachs, Kawasaki Kolben Gaskets Needle cage Oil seals

Kohler	dia mm	ccm/cm3	gasket	needle cage	oil seal magn	oil seal
Kohler 340 moottori						
09-670	62,00	340 2-syl		35-520	09-104	09-113
09-670-01	62,25					
09-670-02	62,50					
09-670-04	63,00					
Sachs						
Sachs 440						
09-SM127	67,40	436 2-syl			09-116	09-127
Kawasaki						
Kawasaki 440 Kawasaki Intriguer, Intruder, Invader; Drifter 440 1978-81						
09-689	68,00	440 2-syl		35-522	09-14603	09-14603
Invader 340 F/C 1978-80, Inviter 340 F/C 1978, Drifter F/C 1979-81						
09-685	60,00	339 2-syl	61	35-525		

Windschutzscheiben

Hinweis: immer messen Sie die Höhe der Windschutzscheibe aus dem Licht Öffnung entlang der Oberfläche.

00-110	5 393 062	GL 250 - >88
00-111	524090X	GL 250 S, GL 230 89->91
00-112	526754	GL 360 S 92->95
00-115		539504 Forest Fox 96->98, 01
00-120	522842X	GL 3900, GLX 5900 steel brackets->93
00-121	538284-1	GLX 5900, with screws 1995
00-122	523192X	GLS 3300 low
00-123	538616	GLX 5900, 1995
00-130	524126X	GL 3300, GL 3900 S, 88->92
00-133	538837	COBRA 94->95, ULTRA 94->96
00-140	5393890-1	640
00-141	6500202-2	650 with screws 1995
00-142	533084X	650 steel bracket 83->94
00-151	537644	RANGER, LIGHT, GT 93->97
00-181	5241686	GLX 5900 96->99, 6900 1997
00-300	Nordik 300	
00-377	Nordik 377 R	
00-500	Nordik 500, 600, 7 slots	
00-510	Trapper, 5000, 5 slots	
00-550	Nordik 550	

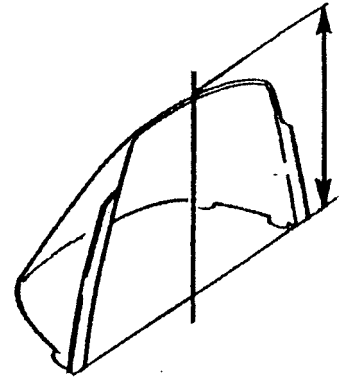

Original-Produktion



12-165 Mirror

Vintage Modelle



37-08



41-40

37-08 Ockelbo Gummifeder



00-600 Lynx decals 1969-75

00-601 Head, decal, whit. 1969-75

00-602 Team Lynx ecal, -80 cent.

41-40 Rear Federn Lynx 40, 30, 20

41-535 Federn, wheel boogie Lynx

Bremsklötze

Arctic Cat



05-15225 pair
AC 0109-932

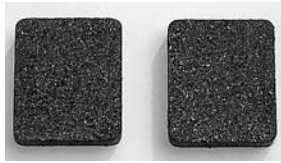

05-15232 pair
AC 0115-603



05-15240 pair
AC 0702-264

Polaris



05-15241 pair
AC 0702-229

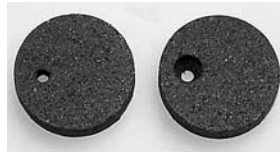

05-15203 pair
Pol 193034/5



05-15214 pc
Pol 1930 569



05-15231 pc
Pol 1930 588



05-15237 pc
Pol 1930 586



05-15243 pair
Pol 1930 723

Ski-Doo Lynx

Nordik

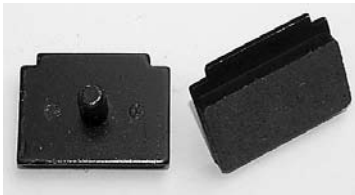

05-15212 pair
Sk 860.701.400



05-15235 pair
Skidoo, Lynx, Nordik



05-15247 pair
Sk 860.701.700



05-15241 pc
Sk 414.933.700
Lynx

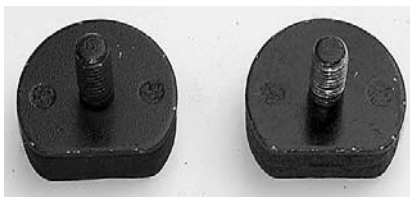

05-15242 pair
Sk 860.700.700
Lynx



05-15246 pc
Sk 414.990.000
Lynx

Bremsklötze Yamaha



05-15224 pair



05-15228 pc



05-15245 pc



05-15249 pair

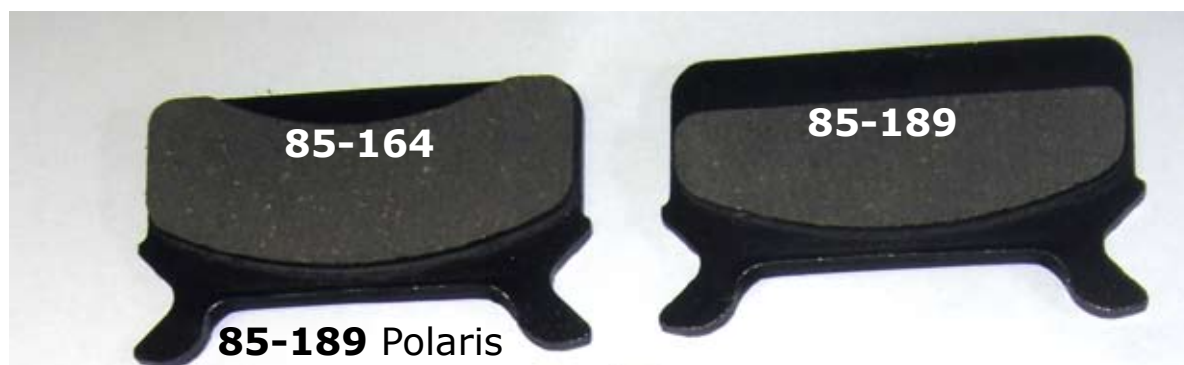

85-164

85-189

85-189 Polaris
Widetrack 99-2003

85-189
Polaris
Widetrack
1997-2005



85-200



85-188



85-200 Skidoo
Mxz 500 2003
Legend 2002

85-188 Polaris
2003-2009



85-184



85-167

85-184 Lynx
86-1993

85-167 Polaris
Supertrack 1992
Widetrack 91-93



85-183



85-179



85-162

85-183 Lynx 535,
GL3900 84-86
650 ja 5900- 84

85-179 Ockelbo

85-162 Lynx 535,
3900 84-87
Lynx5900, 650 89-90

Kette Spezifikationen

(Silent, Hyvo, DID)

Pict	Prod	Platten	Platten stapeln	ID Stamp	Manufacture	Note.
1	45-	11	1-2-1-1-1-1-1-2-1	LB S37 U.S.A	Rexnord	Silent 11
2	46-	13	1-2-1-1-1-1-1-1-1-2-1	LB S37 U.S.A	Rexnord	Silent 13
3	50-	15	1-2-2-2-1-2-2-2-1	LB S37 U.S.A	Rexnord	Silent 15
4	ei	13	1-1-1-1 (x 13)	DID	D.I.D	
5	ei	15	1-1-1-1 (x 15)	DID	D.I.D	
8	ei	15	??	Morse	Borg Warner	Hyvo 7/8
7	52-	13	1-2-1-1-1-1-1-1-1-2-1	Morse	Borg Warner	Hyvo 3/4

Rexnord

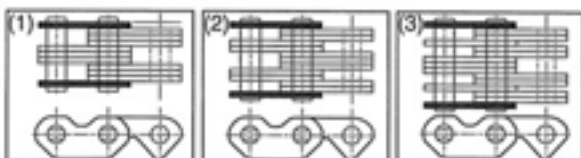

Bilder zeigen die alten Platten stapeln, aber Dies sind die aktuellen eingesetzt werden können, solange der Stempel derselben ist. Es ist die häufigste Chain-Modell. **Silent**

Borg Warner

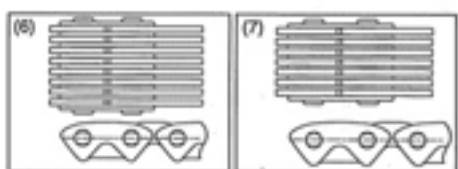

Bilder zeigen die alten Platten stapeln, aber diese sind die Strom kann verwendet werden, solange die Marke die gleiche ist. Handelsnamen, **Hyvo 3/4**

D.I.D.

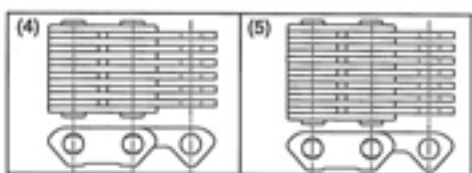

DID Kette Yamaha in den 1990er Jahren verwendet. Seltenes Modell.

Lower Kettenräder, Skidoo, Lynx

13 Breite	Z	13 Breite	Z	15 Breite	Z	15 Breite	Z
steel		aluminium		steel		aluminium	
55-43	43	56-43	43	58-43	43	60-43	43
55-44	44						
55-45	45	56-45	45	58-45	45	60-45	45

Kettenräder, 7 / 8 "-13 Spline

Arctic Cat all, not Diamond drive, Polaris up to 1996

11-Breite	Z	11-Breite	Z	13-Breite	Z	13-Breite	Z
47-016	16	47-021	21	48-016	16	48-021	21
47-017	17	47-022	22	48-017	17	48-022	22
47-018	18	47-023	23	48-018	18	48-023	23
47-019	19	47-024	24	48-019	19	48-024	24
47-020	20			48-020	20		

Silent Kette

11 Breite	length	13 Breite	length	15 Breite	length
45-064	64	46-064	64	50-064	64
45-066	66	46-066	66	50-066	66
45-068	68	46-068	68	50-068	68
45-070	70	46-070	70	50-070	70
45-072	72	46-072	72	50-072	72
45-074	74	46-074	74	50-074	74
45-090	90	46-076	76	50-076	76
		46-104	104	50-078	78
		46-106	106		
		46-108	108		



3/4" Hyvo Kette

Original Borg Warner chain

3/4" Breite	Länge		3/4" Breite	Länge
52-66	66		52-80	80
52-68	68		52-82	82
52-70	70		52-86	86
52-72	72		52-90	90
52-74	74		52-92	92
52-76	76		52-94	94
52-78	78			

Kettenräder, Skidoo, Lynx

11 Breite	Z	13 Breite	Z	15 Breite	Z
45-016	16	46-016	16		
45-017	17	46-017	17		
45-018	18	46-018	18		
45-019	19	46-019	19	50-019	19
45-020	20	46-020	20	50-020	20
45-021	21	46-021	21	50-021	21
45-022	22	46-022	22	50-022	22
45-023	23	46-023	23	50-023	23
45-024	24	46-024	24	50-024	24
		46-025	25	50-025	25
		46-026	26		



CDI-Zündboxen



01-14342
Rotax 410.918.900



01-14343
Rotax 420.965.591



01-401
Arctic Cat 3004-099



01-14340
Rotax 420.866.595



01-415
Yamaha 8V0.85540.21



01-407
Polaris 3083725



01-14345
Rotax 420.965.757



01-40701
Polaris 3083989



01-40801
Polaris 3084007



01-14329
Arctic Cat 3003-777



01-14372
Skidoo 512.058.927 Form.

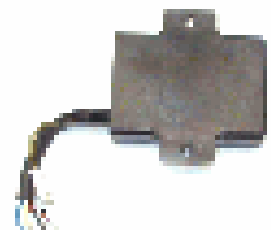

01-406
Pol. 3083721 600-650



01-404
Polaris 308 3723



01-14327
Arctic Cat



01-14332
Bosch, Skidoo, Motoski

Zündspulen



01-14310
Rotax 410.916.000



01-14311
Rotax 410.913.500 Arctic



01-14319



01-14312
Arctic Cat 3003-221



01-14313
Polaris 3082974



01-143120
Arctic Cat 3003-977



01-14314
Yamaha 8W3.82310.10



01-14315
Yamaha 8E7.82310.10



01-14317
Yamaha 5.82310.40



01-14351
Yamaha 8AB.82310.10



01-14353
Arctic Cat 3003-575



01-14355
Rotax 10.920.500



01-14350
Yamaha Bravo 250 -88



01-14363
AC 3005-381 ZL-ZR 5-700



01-14371
Rotax 420.996.705
Form. III, Mach1, Z, ZR

Zündspulen



01-14360
Arctic Cat 3004-126



01-14361
Arctic Cat 3004-483



01-14362
Polaris 3084469



01-1430
Rotax, Bosch, Arctic Cat



01-14367
Polaris 3085293



01-14370
Formula 415.085.400

Sicherheitsstopp swicth



01-113 Arctic Cat



01-11120
Skidoo



01-11113
Yamaha, Arctic Cat, Polaris



01-112



01-120
Universal, oldies
Push-stop-model

Zündkerze



BOSCH

05-B8 BR8ES resistor type
05-B9 BR9ES resistor type

Spannungsregler

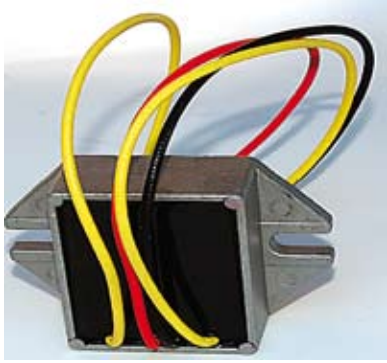

01-15416 **3 wires**
01-15416B **4 wires**



01-15402
Rotax 410.908.900



01-15406
Rotax, Arctic Cat



01-15417 **250 W**
Voltage Regulator Rotax



01-15415
Rotax 410.908.900



01-15421
Polaris 4060122



01-15418
Voltage Regulator Arctic Cat



01-15426
Arctic Cat 0232-014



01-15432
Yamaha 82F.81910.



01-15435
Yamaha 82M.81910.AO



01-15436
Yamaha 98A.81910.00

Zündkerzenkappe



01-110



01-1011

Starter-Motoren



01-0912 Polaris

Polaris: 417 0006
 Artco: 0645-184
 1997-2007



01-0201 Arctic Cat

Artco: 0745-018
 -030,-052,-257
 1991-2007



01-0202 Arctic Cat

Artco: 0645-183
 -312,
 1995-2002



01-0203 Arctic Cat

Artco: 0745-143
 -126,-356
 2001-2007



01-0204 Skidoo

BRP: 515-175-562
 515-175-843
 515-176-003
 2000-2007



01-0228 Kubota

Kubota: 70000-65440
 Denso: 228000-6910
 Denso: 228000-6911



01-0206 Yamaha

Yamaha:
 8BB- 81800-01-00
 1994-2005



01-0207 Yamaha

Yamaha:
 8CW- 81800-00-00
 8CW-81800-01-00
 19947-2005



01-0229 Denso

Denso: 228000-1670
 Denso: 228000-1671
 BRP: 410-207-500

Starter-Motoren

01-0192		DG-0058-1 9-tooth Drive gear 	CB-0092-10 Brush holder Assembly 	Repl.: UT 5698340; Polaris 4170006
01-0201		DG-0058-1 9-tooth Drive gear 	CB-0092 Brush holder Assembly 	Repl.: ARCTCO 0745-018, -030, -052, -257
01-0202			CB-0092-1 Brush holder Assembly 	Repl.: ARCTCO 0645-183, 0645-312
01-0203			CB-0092-10 Brush holder Assembly 	Repl.: ARCTCO0745-143
01-0204		DG-0091-1 8-tooth Drive gear 	CB-0210 Brush holder Assembly 	Repl.: 428000-1101, -3530; Ski-Doo 515-175-562, -843, 515-176-003, -133
01-0205		BRP: 410-212-400		Repl: Bombardier 410-212-400
01-0206		DG-0092-1 9-tooth Drive gear 	CB-0063 Brush holder assembly 	Repl.: Yamaha 8BB-81800-01-00
01-0207		DG-0093-1 9-tooth Drive gear 	CB-0140-1 Brush holder Assembly 	Repl: Yamaha 8CW-81800-00-00, 8CW-81800-01-00
01-0228		DG-0095-1 9-tooth Drive gear 	CB-0140-1 Brush holder Assembly 	Repl.: Kubota 70000-65440
01-0229		DG-0095-1 9-tooth Drive gear 	CB-0140-1 Brush holder Assembly 	Repl.: Denso128000-1670, 128000-1671

	PROPELLERS	HP	DIAMETER/PITCH
YAMAHA	6F8-45942-00-36	2	7 1/4*5-A
	683-45943-00-EL	9,9	9 1/4*10 1/2 J
	683-45945-00-36	9,9	9 1/4*9 J
	683-45952-00-EL	9,9	9 1/4*9 3/4 J
	626-45943-02-36	9.9/15	9 1/4*10 3/4 D
	626-45949-01-36	9.9/15	9 1/4*9 D
	648-45941-01-EL	25	9 1/2*11 1/2 D
	664-45945-00-EL	25/30	9 7/8*10 1/2F
	664-45949-02-EL	25/30	9 7/8*13F
	676-45941-62-EL	40	11 1/2*11 H
	676-45943-62-EL	40	11 1/2*12H
	676-45945-62-EL	40	11 3/4*10H
	676-45956-61-EL	40	11 3/4*7 1/2H
	663-45945-02-EL	48/55	11 1/8*13G
	663-45947-02-EL	48/55	11 5/8*11G
	663-45952-02-EL	48/55	11 3/8*12G
	663-45956-01-EL	48/55	12 1/4*9G
	663-45947-02-EL (S)	48/55	11 5/8*11G
	6E5-45945-01-EL	75/85/115/140	13 1/4*17K
6E5-45947-00-EL	75/85/115/140	13 1/2*15K	
6E5-45949-00-EL	75/85/115/140	13 5/8*13K	
6E5-45947-00-EL (S)	75/85/115/140	13 1/2*15K	
6G5-45978-03-98	(S)150/200	13 3/4*17-M27	
6G5-45974-03-98	(S)150/200	13 3/4*19-M2	
XL700	65R-R1321-10	80hp	
SUZUKI	58111-98452-019	□ 2	188*122
	58111-98452-010	□ 2	188*122
	58100-93763-019	□ 15	9 1/4*9
	58100-93723-019	□ 15	9 1/4*9
	58100-93743-019	□ 15	9 1/4*11
	58110-96331-019	□ 20/30	10 1/4*12
	58100-96430-019	□ 20/30	10 1/4*12
	58100-94313-019	□ 40	11 1/2*13
	58100-95353-019	□ 40	11 3/8*14
	8100-95393-019	40	11 5/8*12

PROPELLERS	HP	DIAMETER/PITCH
JOHNSON 391199 □	65/90	13 1/4*17
TOHATSU 362-64101-00 353-64104-00	9.9/15 60/70	9,0 12
MERCURY 48-168999 (S)	60	10 1/8*15P



663-45947
-02-EL



663-45952
-02-EL



683-45943
-00-EL



6E5-45945
-01-EL



6E5-45947
-00-EL



626-45943
-02-36



626-45949
-01-36



663-45945
-02-EL



58100-
94313-019



58111-
98452-010

Impellers



663-11411-01



47-89984



6F5-44352-00



396809



6E5-44352-00



6G5-44352-00

Flip, Unterricht

Bilder:

Auf den Bildern sieht man die Montage eines 384 cm langen Raupe

Um die bestmögliche Ausrichtung nachverfolgen zu erreichen, montieren Sie die Welle so weit nach links wie möglich.

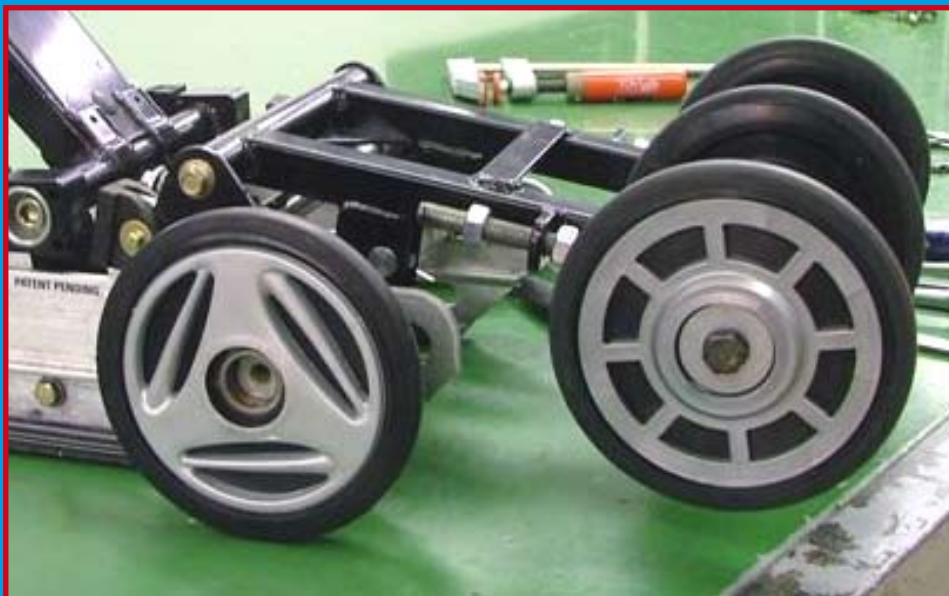
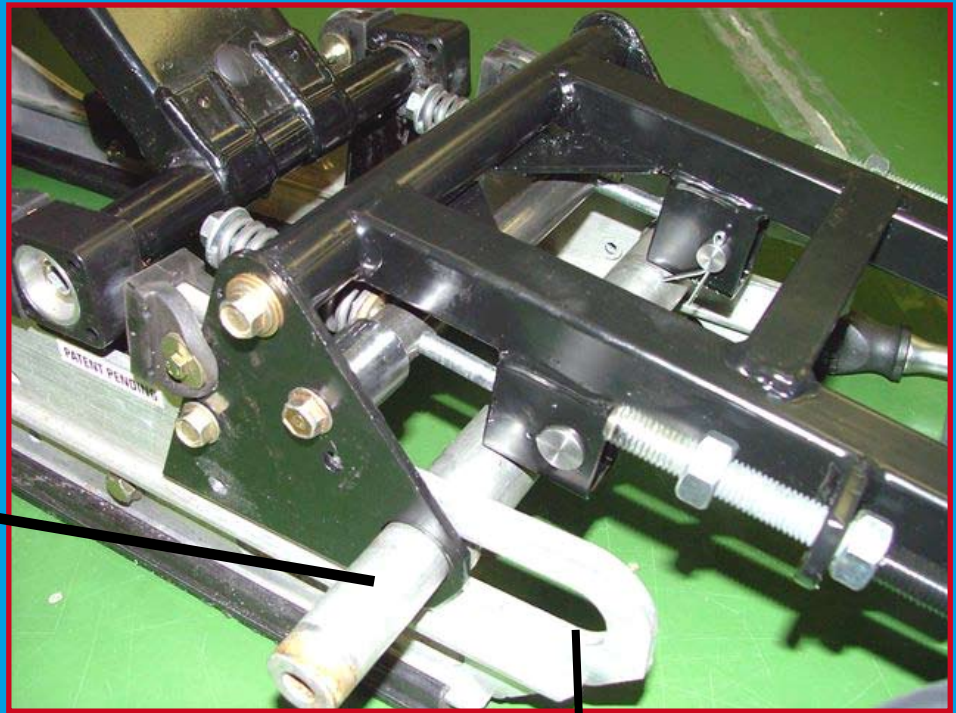

Pictures:

In den Bildern, Sie sehen Montage eine 403 cm lange Raupe.

Um die bestmögliche Ausrichtung nachverfolgen zu erreichen, montieren Sie die Welle so weit nach links wie möglich

